

ALEXA

Türzargen
Door frames



Inhalt / Content

ALEXA AT 23

Anschlagtürzarge

single acting door frame

ALEXA AT 23 E

Eckanschlagtürzarge

corner single acting door frame

Seiten / pages 4 - 9

ALEXA AT 44

Anschlagtürzarge

single acting door frame

Seiten / pages 10 - 15

ALEXA AT 50

freistehende Anschlagtürzarge

free standing connecting door frame

Seiten / pages 16 - 19

Zubehör / Accessories **MR 28, MR 22**

Seiten / pages 20 - 21

ALEXA PT 35

Pendeltürzarge / double acting door frame

Seiten / pages 22 - 27

**Neu und superschmal –
die perfekten Alu-Türzargen
für Ganzglastüranlagen:**

- ALEXA AT 23
Anschlagtürzarge
- ALEXA AT 23 E
Eckanschlagtürzarge
- ALEXA AT 44
Anschlagtürzarge
- ALEXA AT 50
freistehende
Anschlagtürzarge
- ALEXA PT 35
Pendeltürzarge

Alle Zargentypen sind auf die passenden DORMA-Glas Beschläge abgestimmt. Bei den Anschlagtürzargen AT 44 und AT 50 werden die Standard-Beschläge mit 24 mm Falztiefe verwendet.

Standard-Oberflächen

- LM silber EV1 (101)
- LM ähnlich Niro matt (113)

Hinweis für Maßfertigung

Alle ALEXA Zargen werden nach Ihren Maßangaben gefertigt. Je nach Anlagen-Typ werden 2, 3 oder 4 Maße benötigt (siehe technische Information und Bestellformular). Damit können alle Türrahmenvarianten erstellt werden.

Die Zargen werden für die bauseitige Montage vorge richtet.

Bitte beachten:

**Die Beschläge müssen
gesondert bestellt werden.**

Technische Änderungen
vorbehalten.



**New and super narrow –
the perfect aluminium door
frame for glass assemblies:**

- ALEXA AT 23
single acting door frame
- ALEXA AT 23 E
corner single acting door
frame
- ALEXA AT 44
single acting door frame
- ALEXA AT 50
free standing
connecting door frame
- ALEXA PT 35
double acting door frame

All frame types have been tuned to fit DORMA-Glas fittings. Standard fittings for a rebate depth of 24 mm are used on the single acting door frames AT 44 and AT 50.

Standard finishes

- aluminium silver EV1 (101)
- aluminium similar satin stainless steel (113)

Note regarding customising

All ALEXA frames are produced to your given measurements. 2, 3 or 4 measurements are needed depending on system type (see technical information and order sheet). With this, it is possible to plan all door frame types.

Door frames are prepared for on site assembly.

Please note:

**Fittings have to be ordered
separately.**

Subject to change without
notice.

ALEXA AT 23
Anschlagtürzarge

für 8 / 10 mm Glas

Mit verdeckter Befestigung, passend für DORMA Spezialbänder Art.-Nr. 11.294, 12.050, 25.450 und Schlösser aus der Studio bzw. Office Serie sowie für DORMA MEDIO.

Max. Türgewicht

- mit 2 Bändern = 40 kg
- mit 3 Bändern = 55 kg

Standard-Oberflächen

- LM silber EV1 (101)
- LM ähnlich Niro matt C 31 (113)

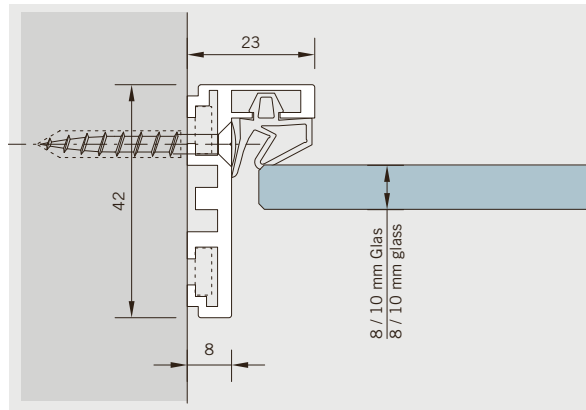
**ALEXA AT 23 single acting**
door frame

for 8 / 10 mm glass

With concealed fixing and suitable for DORMA special hinges Art. No. 11.294, 12.050, 25.450 and locks Studio respectively Office serie as well as for DORMA MEDIO.

Max. door weight

- with 2 hinges = 40 kg
- with 3 hinges = 55 kg

Standard finishes

- aluminium silver EV1 (101)
- aluminium similar satin stainless steel C 31 (113)

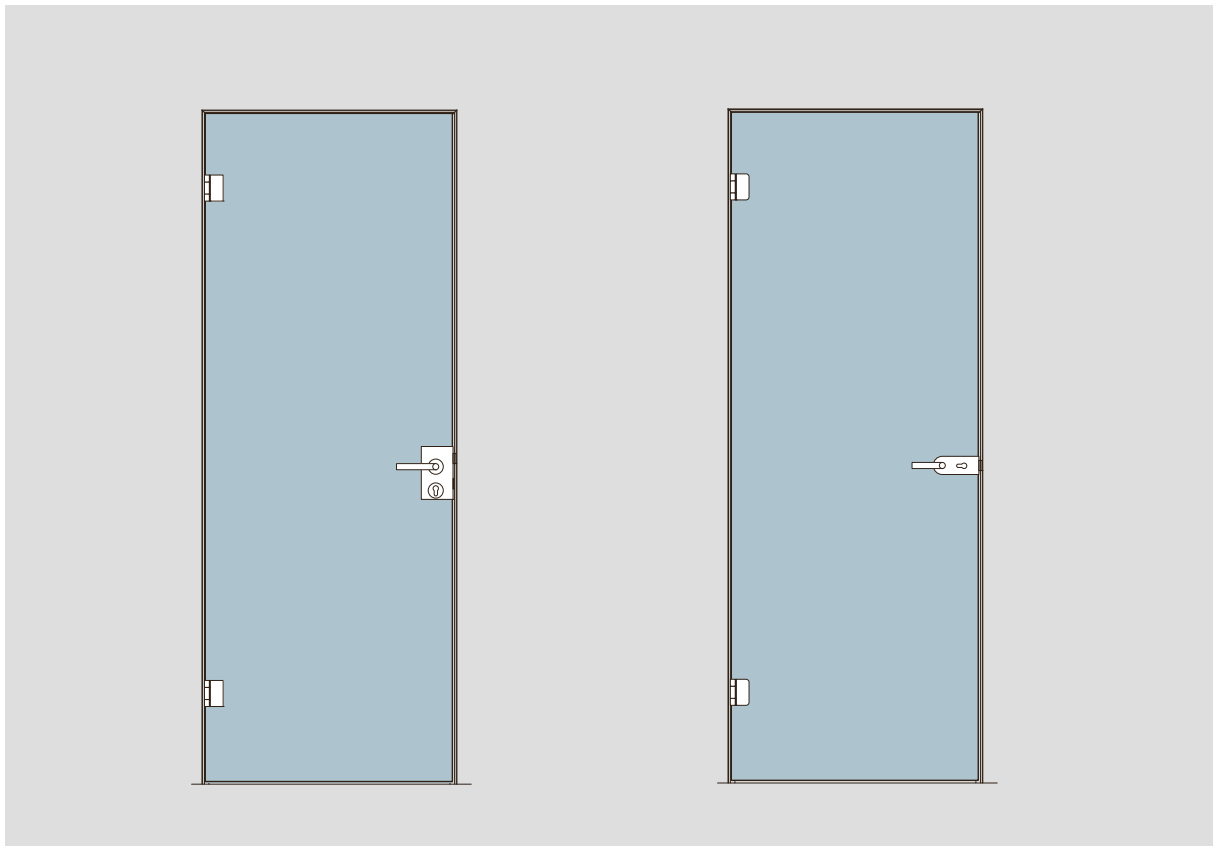

ALEXA AT 23 E
Eckanschlagtürzarge
für 8 / 10 mm Glas

Mit verdeckter Befestigung, passend für DORMA Spezialbänder Art.-Nr. 11.294, 12.050, 25.450 und Schlösser aus der Studio bzw. Office Serie sowie für DORMA MEDIO.

Max. Türgewicht

- mit 2 Bändern = 40 kg
- mit 3 Bändern = 55 kg

Standard-Oberflächen

- LM silber EV1 (101)
- LM ähnlich Niro matt C 31 (113)

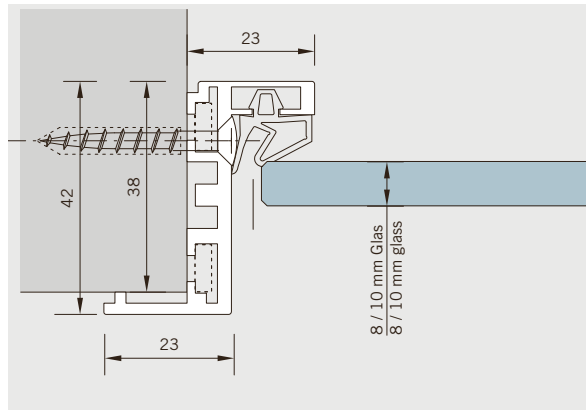
ALEXA AT 23 E corner
single acting door frame
for 8 / 10 mm glass

With concealed fixing and suitable for DORMA special hinges Art. No. 11.294, 12.050, 25.450 and locks Studio respectively Office serie as well as for DORMA MEDIO.

Max. door weight

- with 2 hinges = 40 kg
- with 3 hinges = 55 kg

Standard finishes

- aluminium silver EV1 (101)
- aluminium similar satin stainless steel C 31 (113)

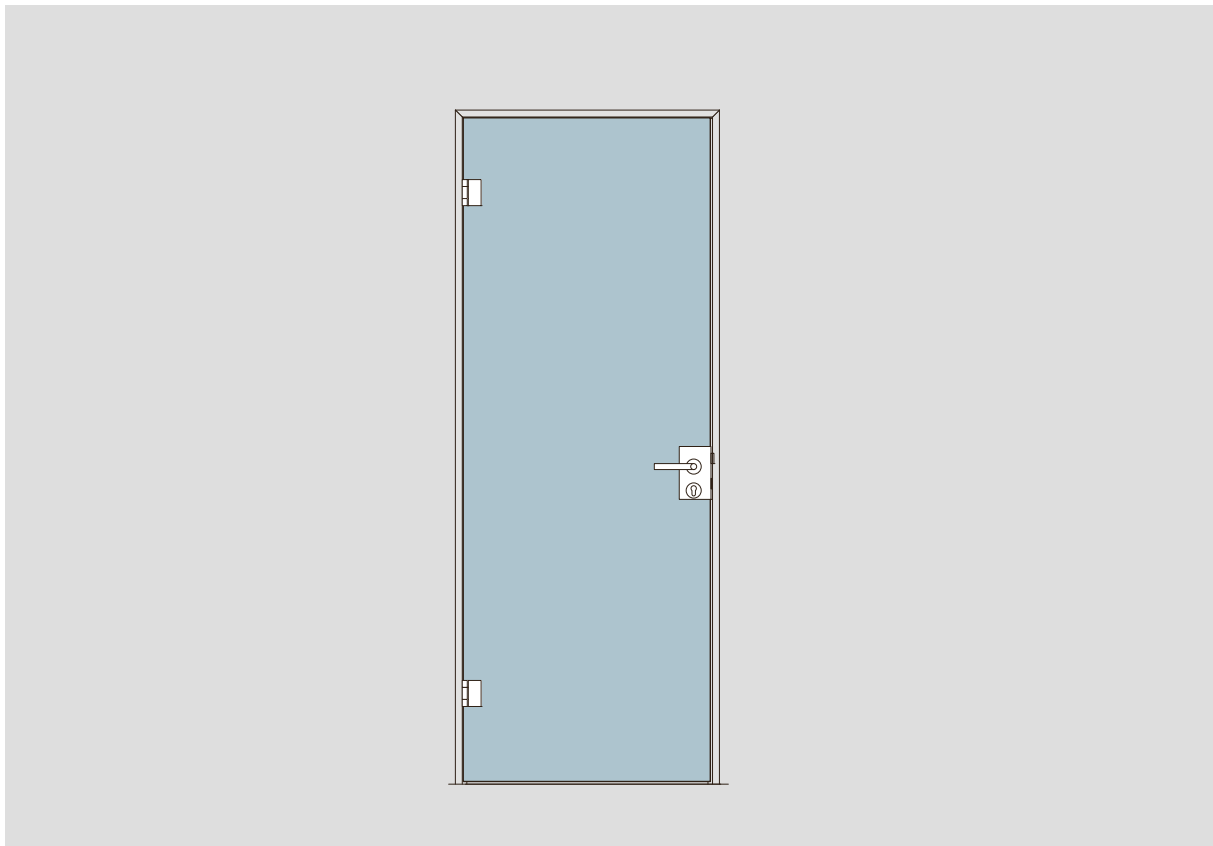

Beschlagvarianten-Beispiele / Fitting type examples

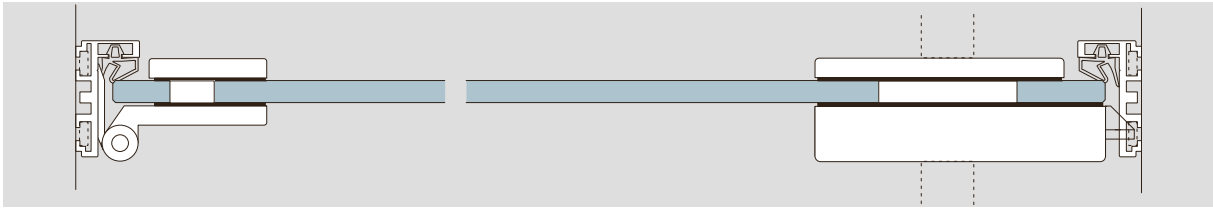

ALEXA AT 23 mit DORMA Spezialband Art.-Nr. 11.294 bzw. 12.050, Schloss (Junior Office, Junior Office Classic)
 ALEXA AT 23 with DORMA special hinge Art. No. 11.294 resp. 12.050, lock Junior Office / Junior Office Classic

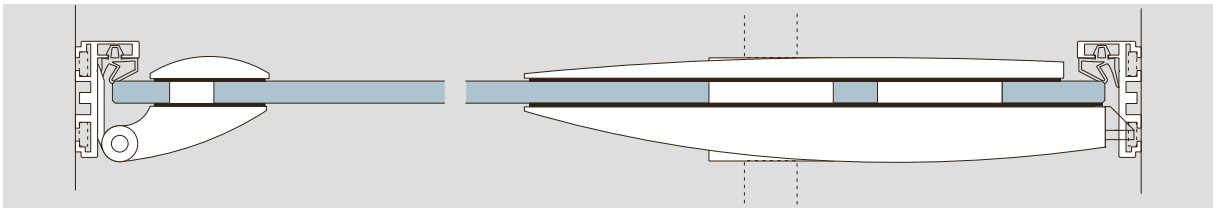

ALEXA AT 23 mit DORMA Spezialband ARCOS Art.-Nr. 25.450, Schloss ARCOS Studio
 ALEXA AT 23 with DORMA special hinge ARCOS Art. No. 25.450, lock ARCOS Studio

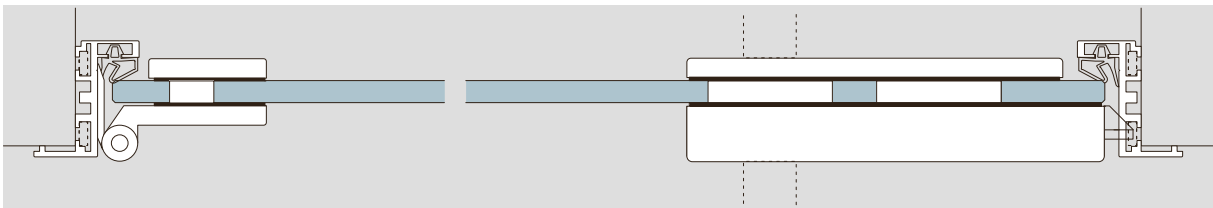

ALEXA AT 23 E mit DORMA Spezialband Art.-Nr. 11.294 bzw. 12.050, Schloss Studio (Rondo, Classic)
 ALEXA AT 23 E with DORMA special hinge Art. No. 11.294 resp. 12.050, lock Studio Rondo / Classic

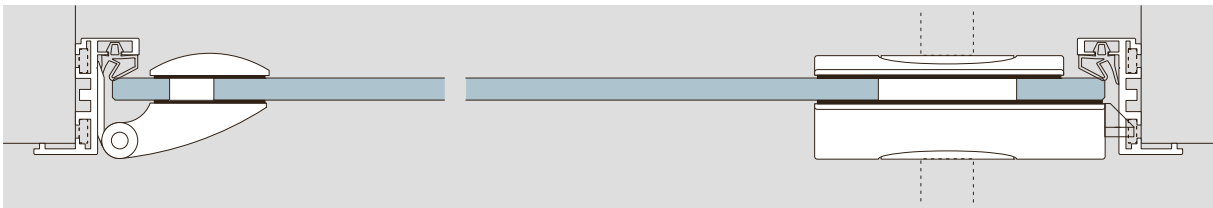

ALEXA AT 23 E mit DORMA Spezialband ARCOS Art.-Nr. 25.450, Schloss ARCOS Office
 ALEXA AT 23 E with DORMA special hinge ARCOS Art. No. 25.450, lock ARCOS Office

ALEXA AT 23 Anschlagtürzarge / single acting door frame

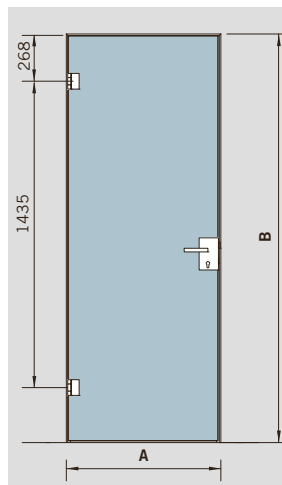
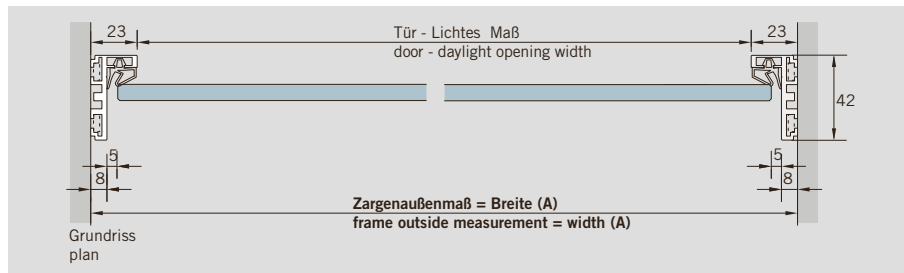
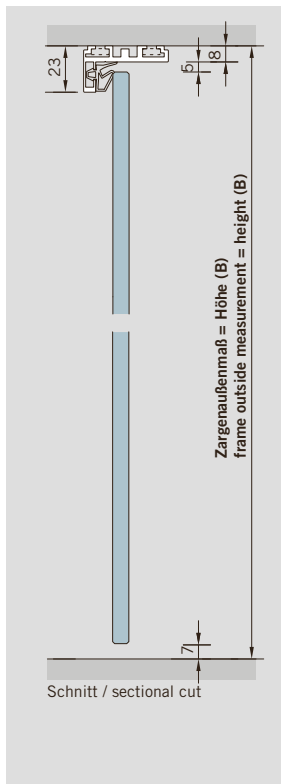

Beispiel für die Maßangaben und definierte Standardmaße für Bänder und Türdrücker.
Example for measurements and set standard measurements for hinges and door levers.

ALEXA AT 23 E Eckanschlagtürzarge / corner single acting door frame

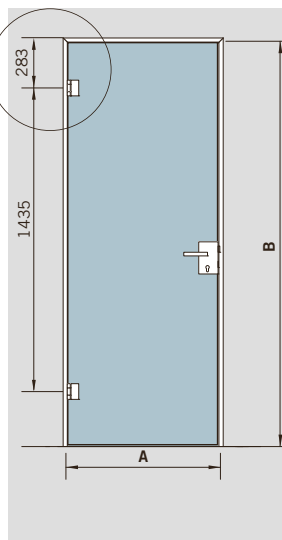
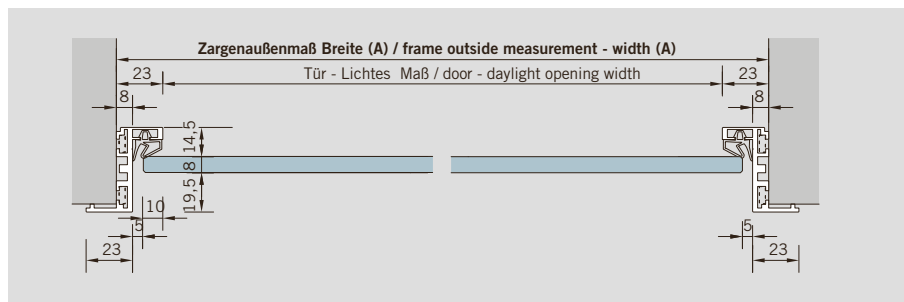
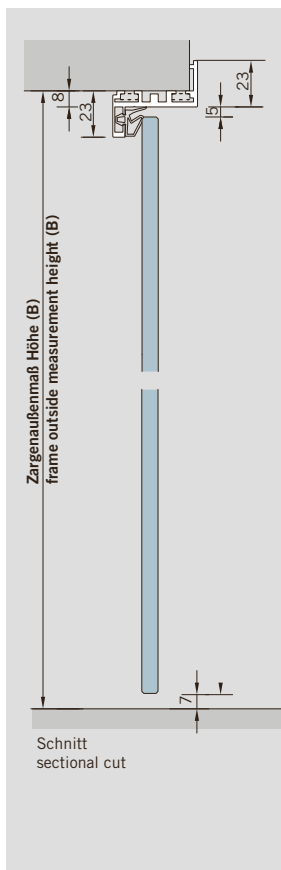

Beispiel für die Maßangaben und definierte Standardmaße für Bänder und Türdrücker.
Example for measurements and set standard measurements for hinges and door levers.

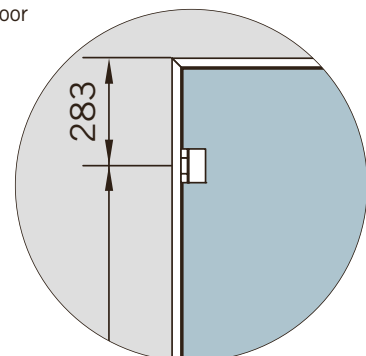

ALEXA AT 23 Anschlagtürzarge / single acting door frame

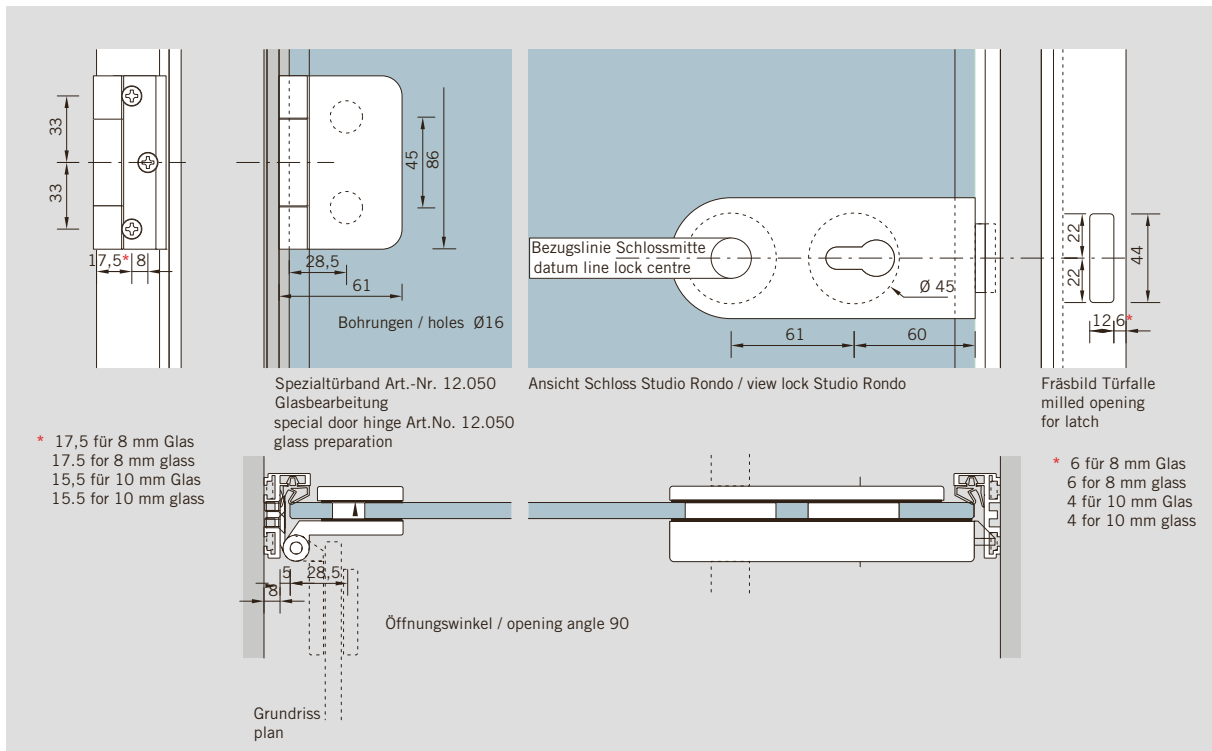

ALEXA AT 23 E Eckanschlagtürzarge / corner single acting door frame

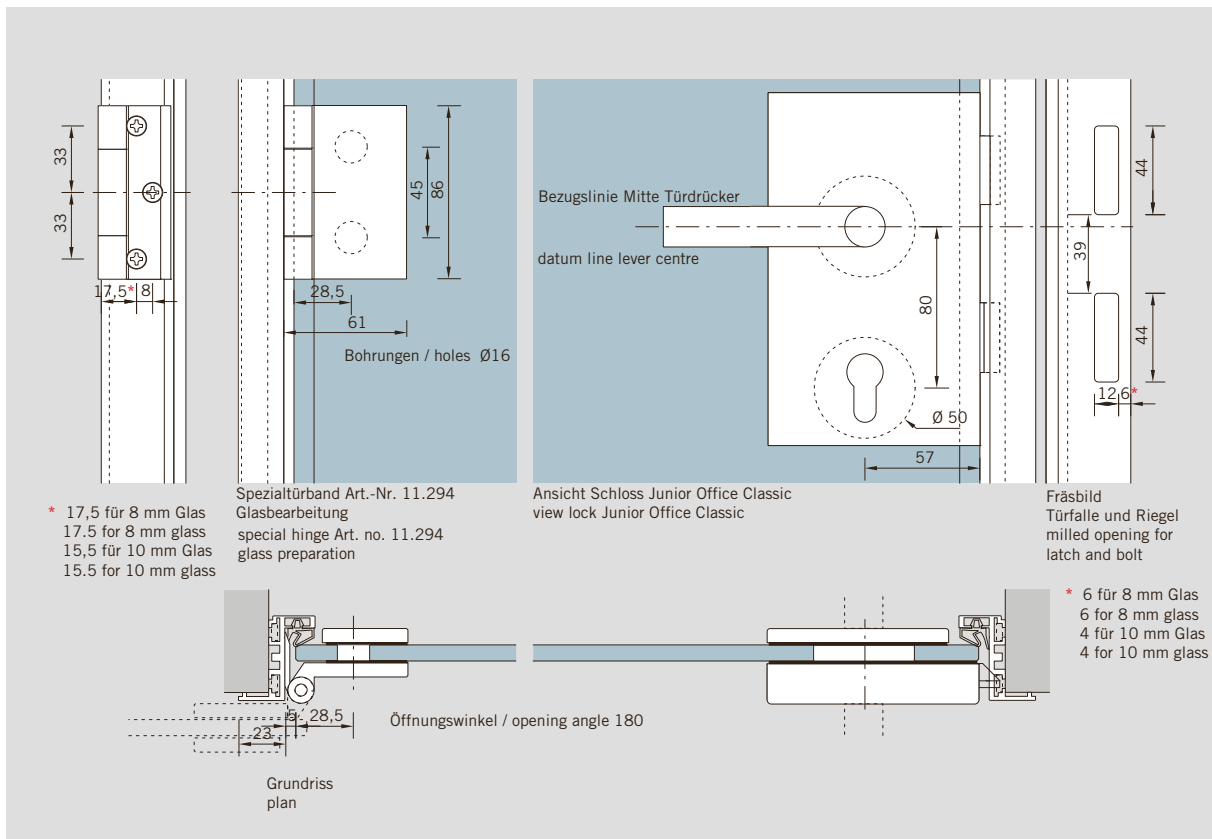

ALEXA AT 23 Anschlagtürzarge / single acting door frame

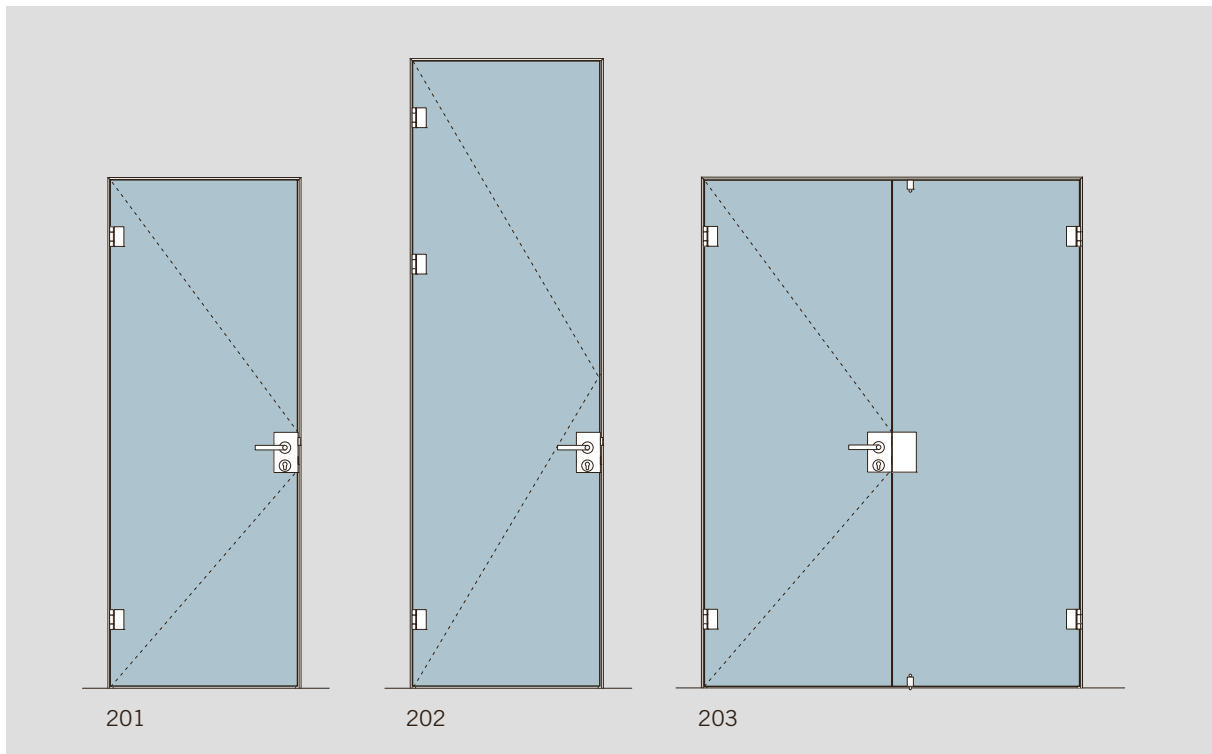

ALEXA AT 23 E Eckanschlagtürzarge / corner single acting door frame

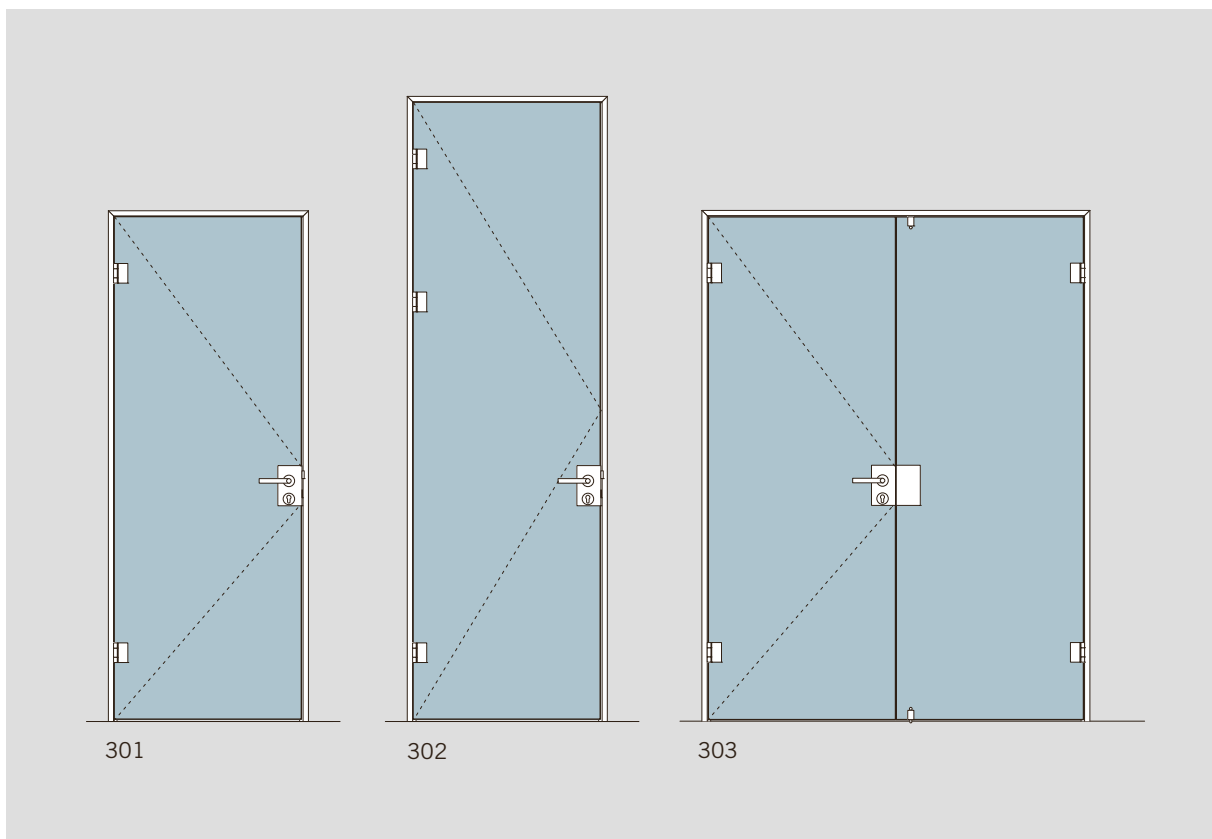

**ALEXA AT 44 –
Anschlagtürzarge für
8 / 10 mm Glas**

Mit verdeckter Befestigung für ein- und doppelflügelige Türanlagen, mit Oberlicht und/oder festen Seitenteilen.

Passend für DORMA Office (ARCOS, Jubior, Classic), Studio (ARCOS, Rondo, Classic, Gala) sowie für MEDIO.

Max. Türgewicht

45 bis 65 kg

Standard-Oberflächen

- LM silber EV1 (101)
- LM ähnlich Niro matt C 31 (113)

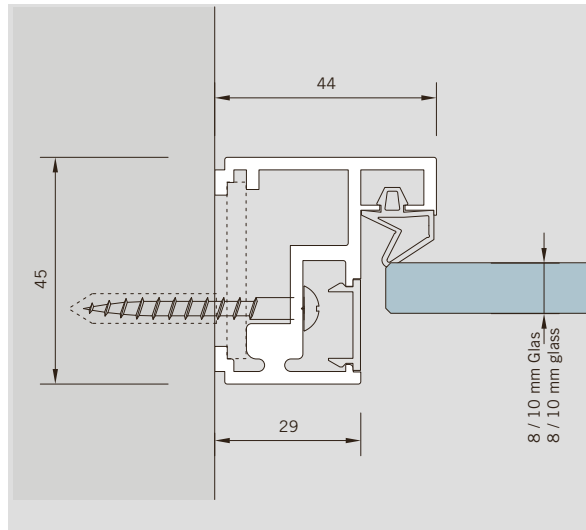
**ALEXA AT 44 –
single acting door frame
for 8 / 10 mm glass**

With concealed fixing for single and double action door assemblies, with over-panel and/or fixed sidelights.

Suitable for DORMA Office (ARCOS, Jubior, Classic), Studio (ARCOS, Rondo, Classic, Gala) as well as for MEDIO.

Max. door weight

45 up to 65 kg

Standard finishes

- aluminium silver EV1 (101)
- aluminium similar satin stainless steel C 31 (113)

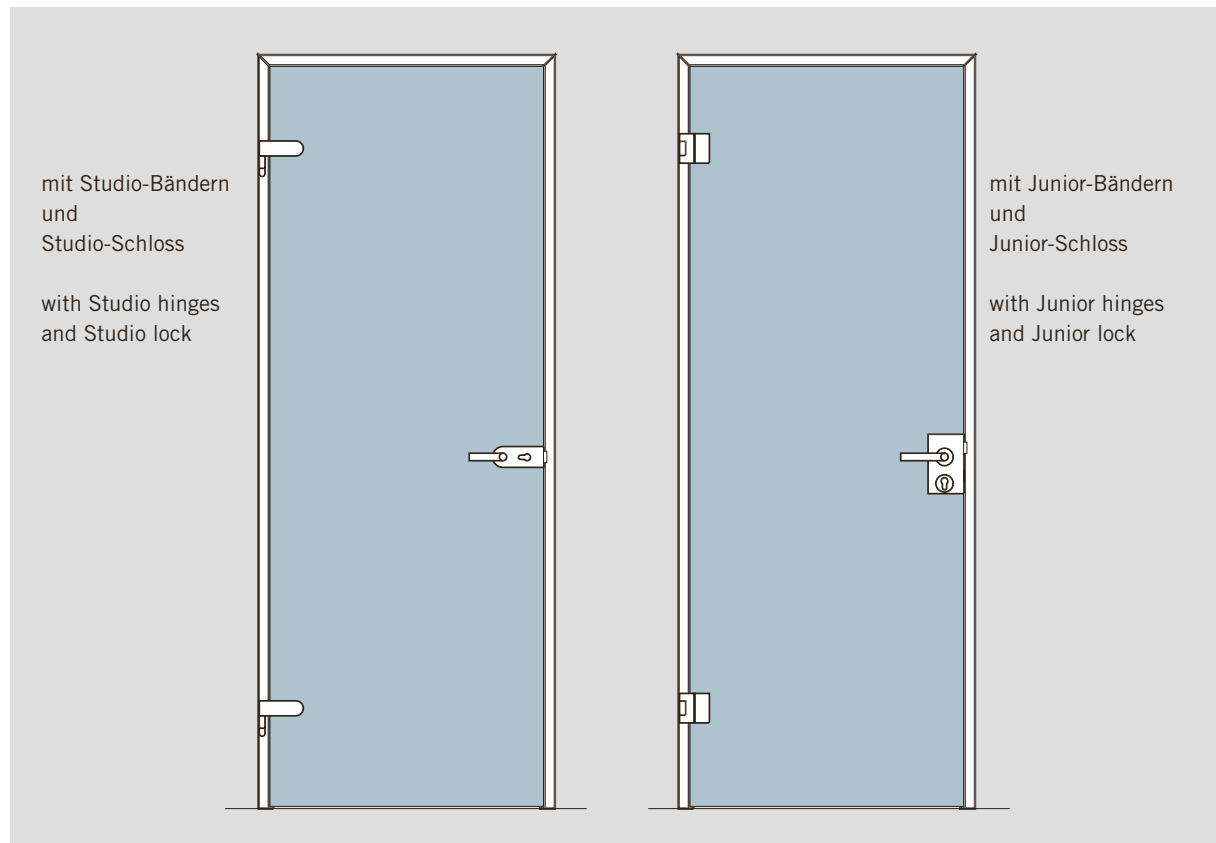
AT 44 – Zargenprofil 3-seitig / frame profile 3-sided

Die Profile / The Profiles

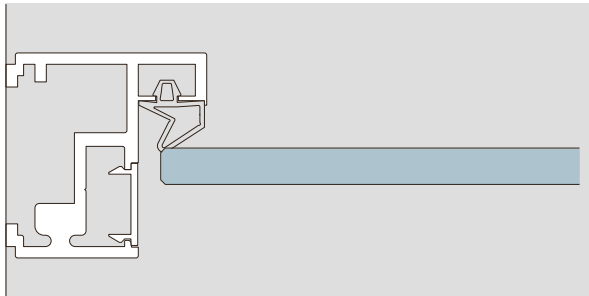

ALEXA AT 44 - Zargenprofil
ALEXA AT 44 - frame profile

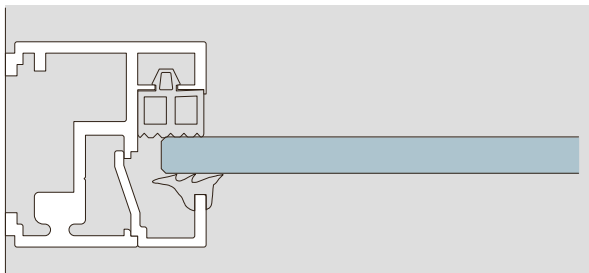

ALEXA AT 44 - Festverglasung
ALEXA AT 44 - fixed glass

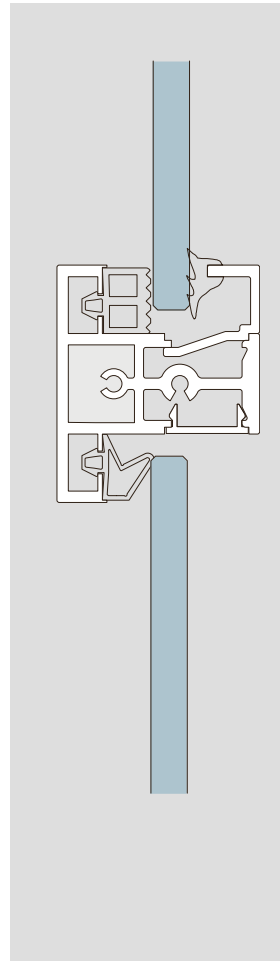

Sprossenprofil
Rung profile

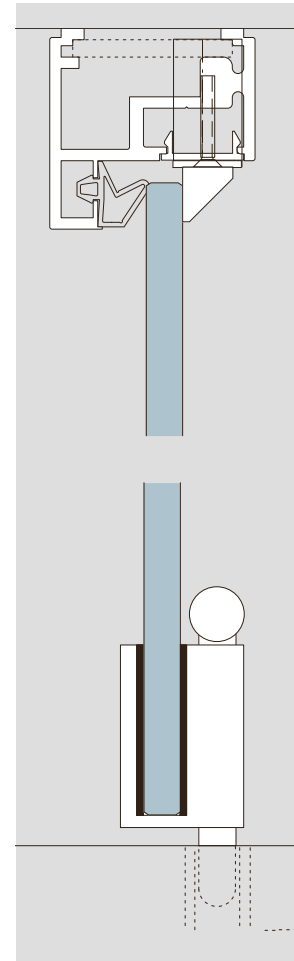

Zargenprofil
Frame profile

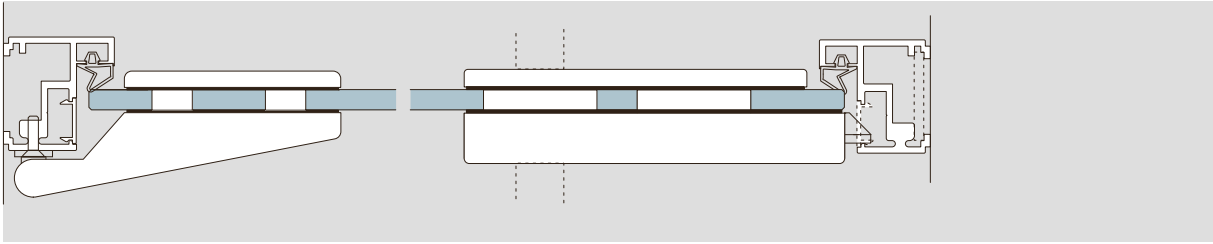
Beschlagtypen Beispiele / Fitting types examples

ALEXA AT 44 - mit DORMA Studio (Classic, Rondo)
 ALEXA AT 44 - with DORMA Studio (Classic, Rondo)

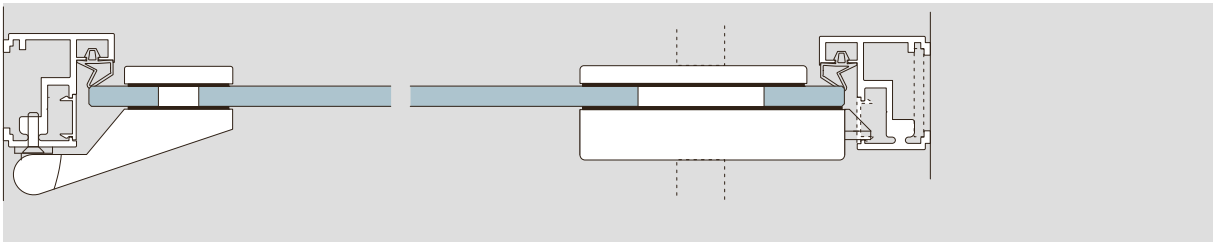

ALEXA AT 44 - mit DORMA Junior (Office, Office Classic)
 ALEXA AT 44 - with DORMA Junior (Office, Office Classic)

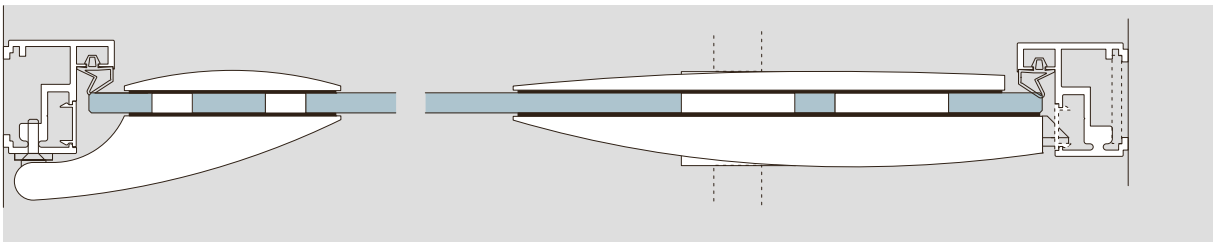

ALEXA AT 44 - mit DORMA ARCOS Studio
 ALEXA AT 44 - with DORMA ARCOS Studio

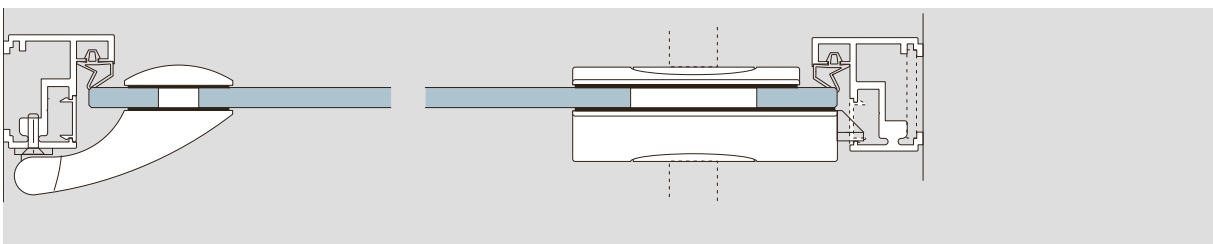

ALEXA AT 44 - mit ARCOS Office
 ALEXA AT 44 - with ARCOS Office

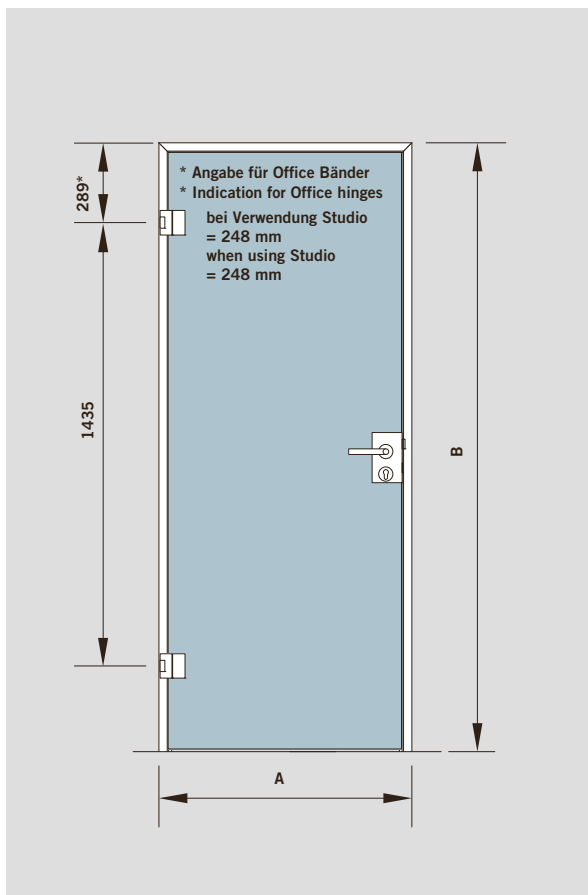
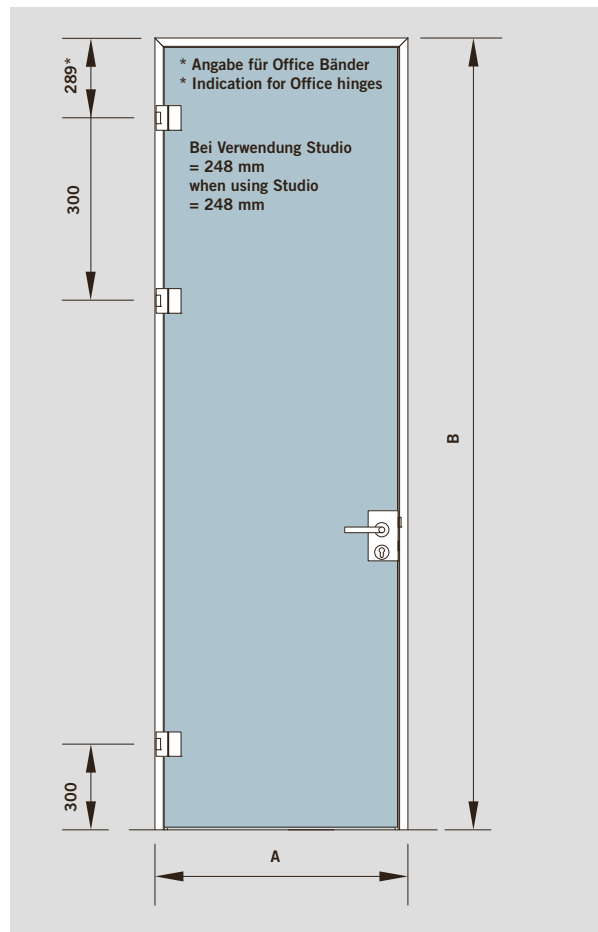
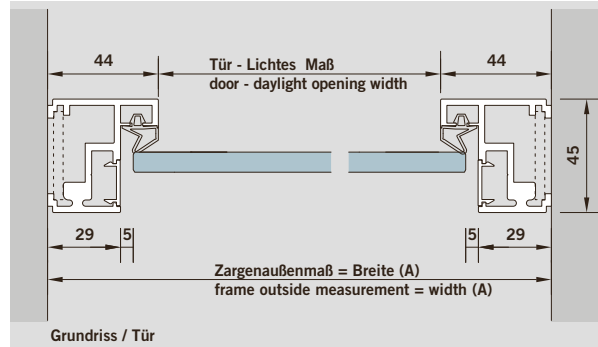
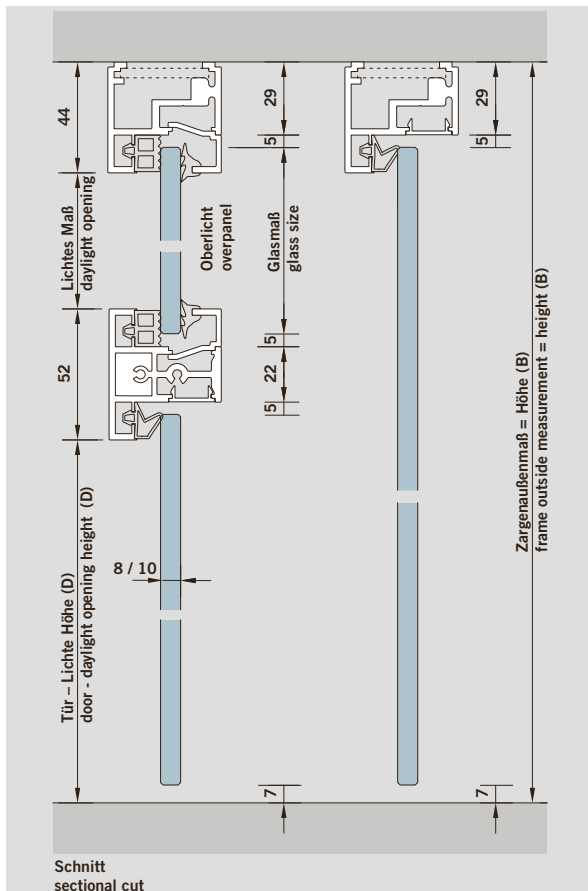

Beispiel für die Maßangaben und definierte Standardmaße für Bänder und Türdrücker

Max. Türgewicht

- Junior Varianten - mit 2 Bändern = 55 kg
- Junior Varianten - mit 3 Bändern = 65 kg
- Studio Varianten - mit 2 Bändern = 45 kg
- Studio Varianten - mit 3 Bändern = 50 kg

Example for measurements and set standard measurements for hinges and door levers

Max. door weight

- Junior types - with 2 hinges = 55 kg
- Junior types - with 3 hinges = 65 kg
- Studio types - with 2 hinges = 45 kg
- Studio types - with 3 hinges = 50 kg

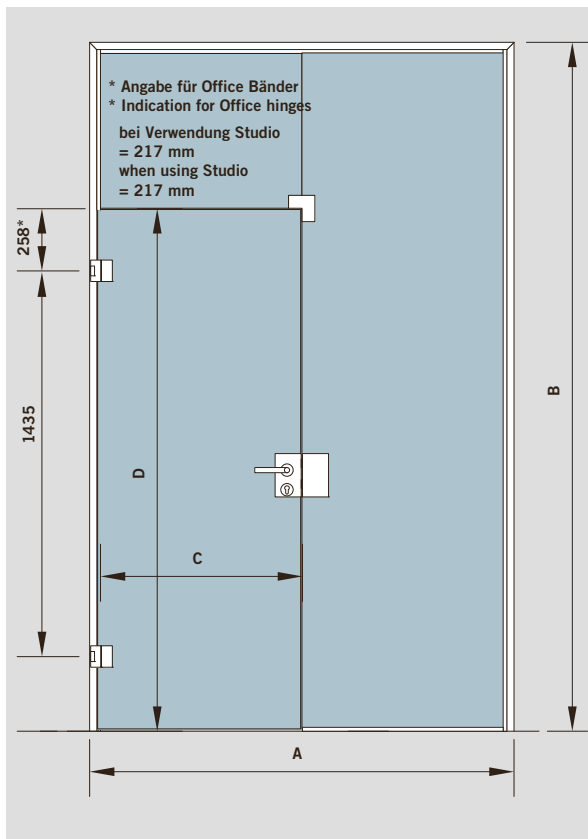
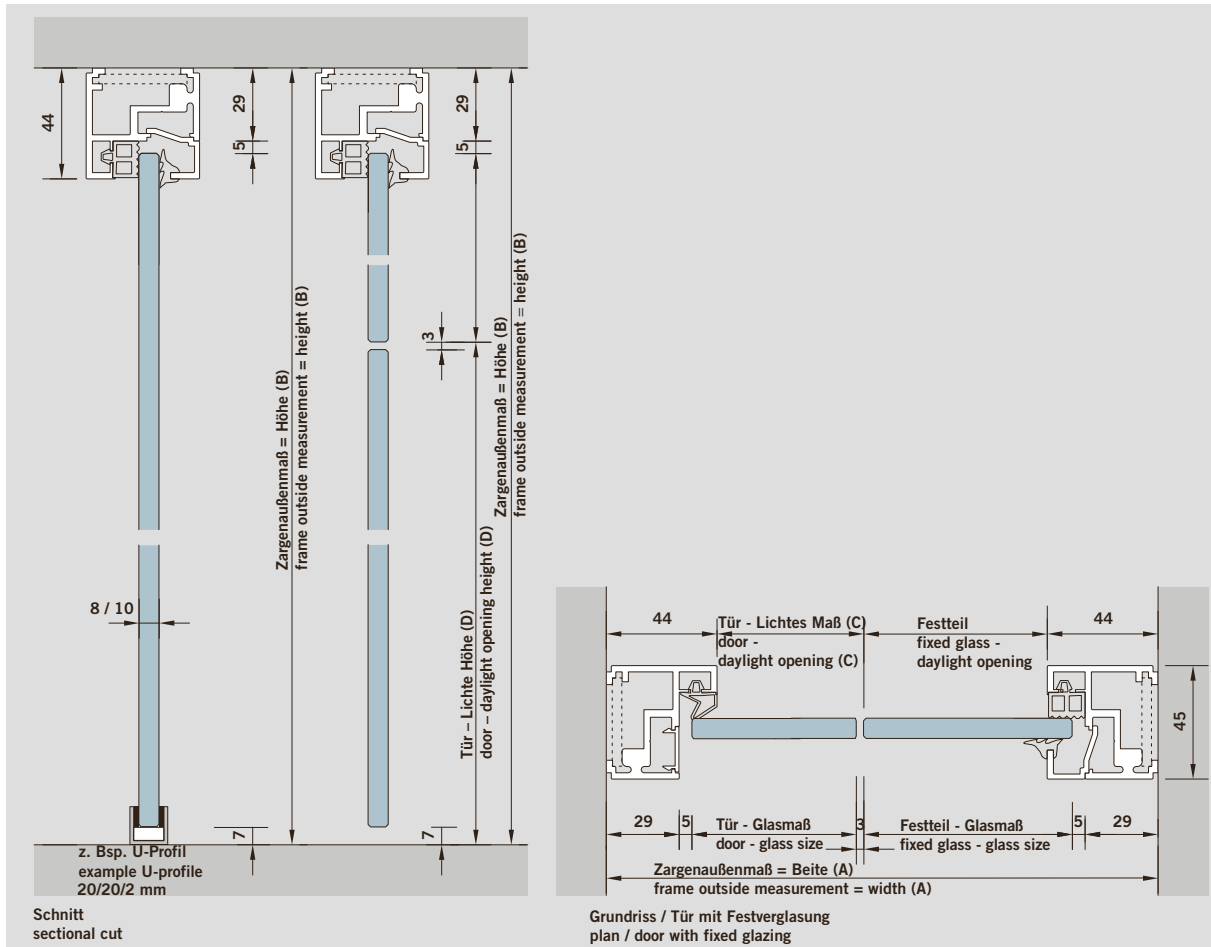

Beispiel für die Maßangaben und definierte Standardmaße für Bänder und Türdrücker

Max. Türgewicht

- Junior Varianten - mit 2 Bändern = 55 kg
- Junior Varianten - mit 3 Bändern = 65 kg
- Studio Varianten - mit 2 Bändern = 45 kg
- Studio Varianten - mit 3 Bändern = 50 kg

Example for measurements and set standard measurements for hinges and door levers

Max. door weight

- Junior types - with 2 hinges = 55 kg
- Junior types - with 3 hinges = 65 kg
- Studio types - with 2 hinges = 45 kg
- Studio types - with 3 hinges = 50 kg

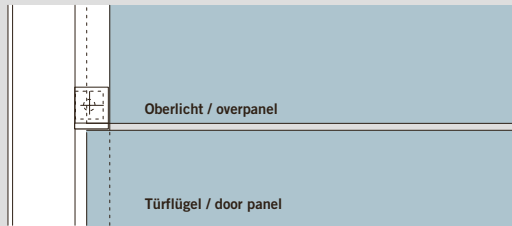

Oberlichtbefestigung / overpanel fixing
Haltewinkel justierbar / adjustable angle bracket

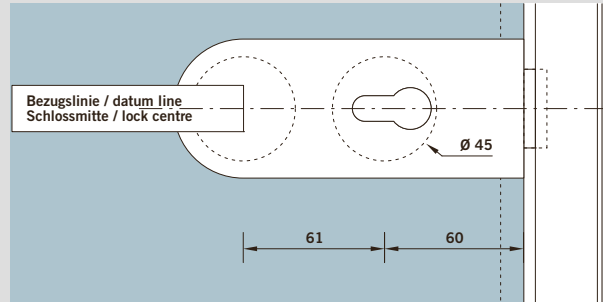
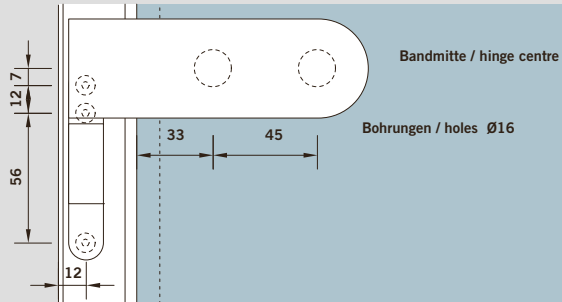

Ansicht Schloss Studio Rondo
view lock Studio Rondo

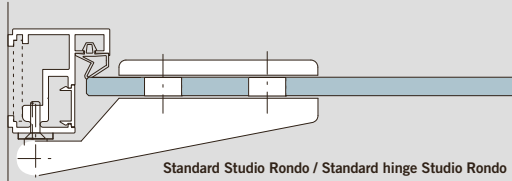

Standard Studio Rondo / Standard hinge Studio Rondo

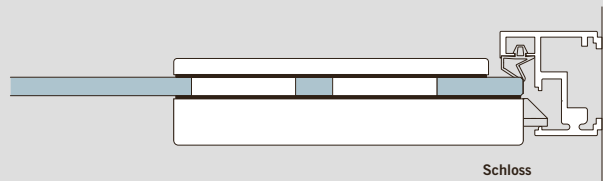

Schloss
lock

Studio Rondo mit Anschraub-Rahmenteil
Studio Rondo with screw-on frame pivot

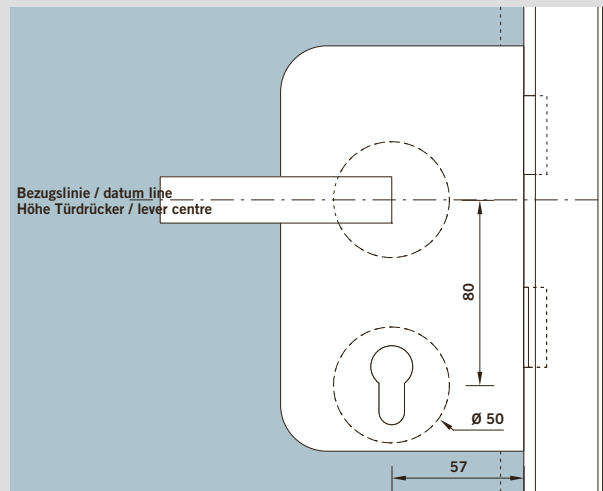
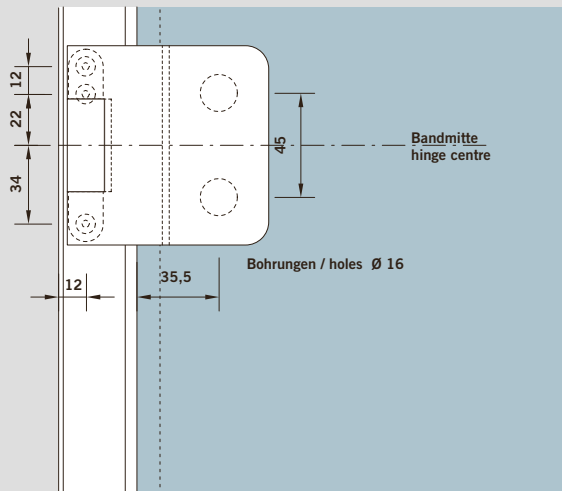

Ansicht Schloss Junior Office
view lock Junior Office

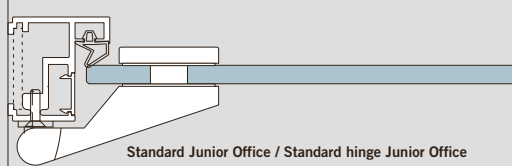

Standard Junior Office / Standard hinge Junior Office

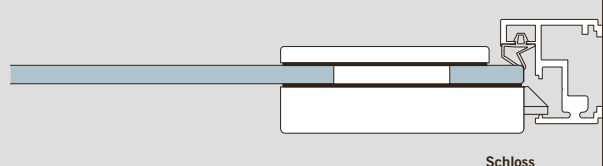

Schloss
lock

Junior Office mit Anschraub-Rahmenteil
Junior Office with screw-on frame pivot

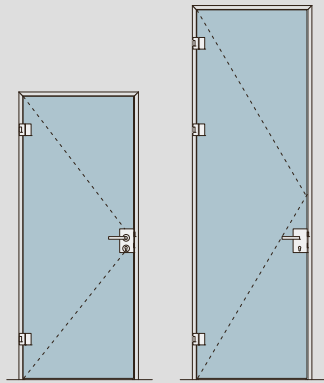

501

502

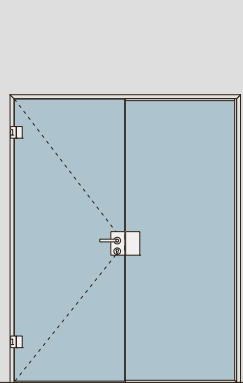

503

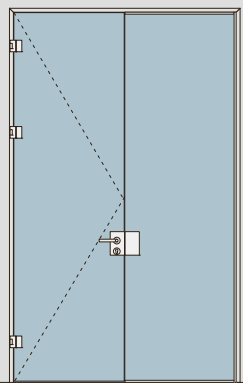

504

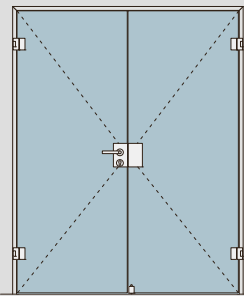

505

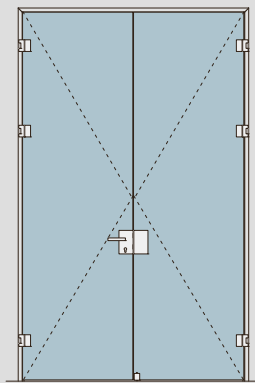

506

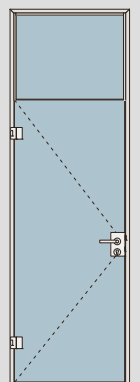

507

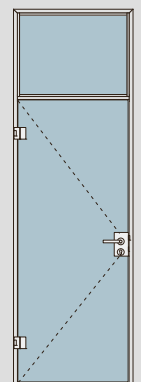

507S
auf Anfrage
on request

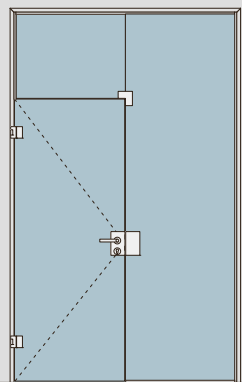

508
auf Anfrage
on request

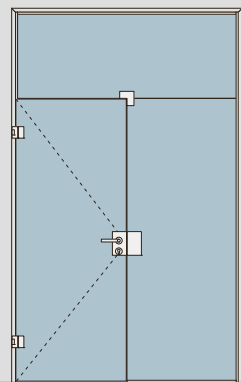

509
auf Anfrage
on request

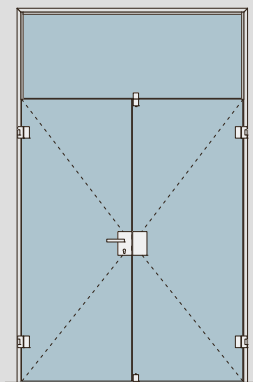

510

**ALEXA AT 50 –
freistehende
Anschlagtürzarge**

für Kombination mit feststehenden Glasseitenteilen und Oberlichtern. Für 8 / 10 mm Glas im Türenbereich. Glasseitenteile und Oberlichter immer vorgerichtet für 10 mm Glas.

Passend für DORMA Office (ARCOS, Junior, Classic), Studio (ARCOS, Rondo, Classic, Gala) sowie MEDIO und DORMA EA.

Max. Türgewicht 45 bis 65 kg

Wandanschluss – der an den Seitenteilen weiterführende Boden- Wand- und Deckenanschluss kann wahlweise mit AT 44 oder MR 28 Rahmenprofilen gestaltet werden.

Bitte bei Bestellung angeben!

Standard-Oberflächen

- LM silber EV1 (101)
- LM ähnlich Niro matt C 31 (113)

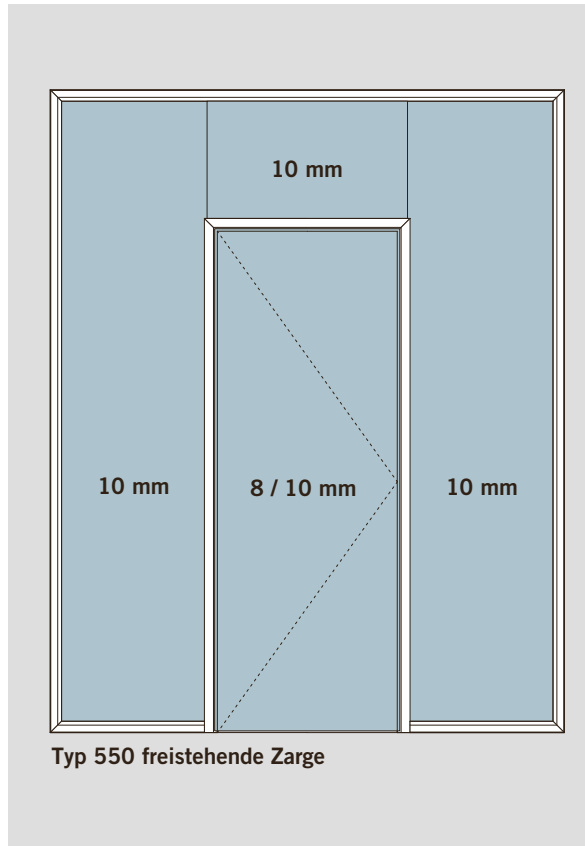
**ALEXA AT 50 –
free standing
connecting door frame**

for combination with fixed glass sidelights and overpanels. For 8 / 10 mm glass in the door area.

Glass sidelights and overpanels always prepared for 10 mm glass.

Suitable for DORMA Office (ARCOS, Junior, Classic), Studio (ARCOS, Rondo, Classic, Gala) as well as for MEDIO and DORMA EA.

Max. door weight 45 up to 65 kg

Wall connection – Both AT 44 and MR 28 frame profiles can be used for the floor, wall and ceiling joints extending across the sidelights.

Please indicate when placing an order!

Standard finishes

- aluminium silver EV1 (101)
- aluminium similar satin stainless steel C 31 (113)

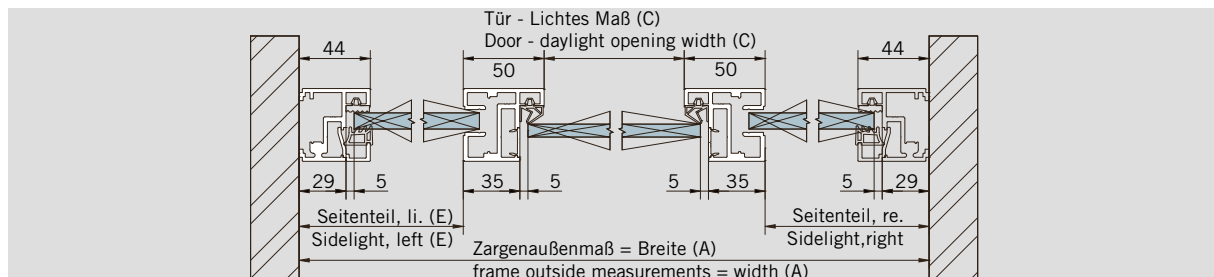

Anschlussrahmen mit AT 44 / Connecting frame with AT 44

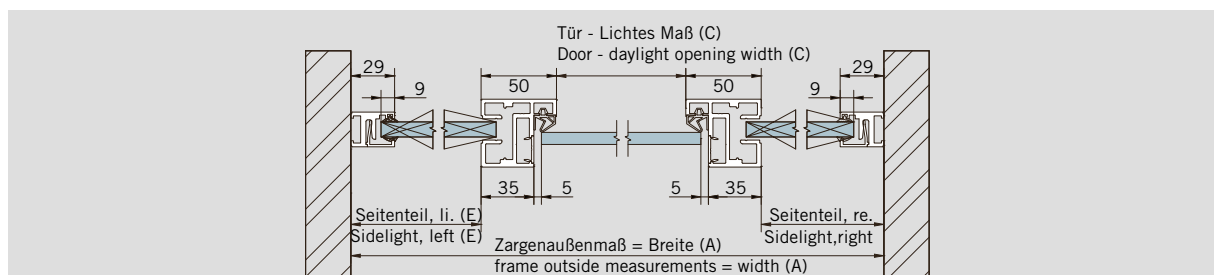

Anschlussrahmen mit MR 28 / Connecting frame with MR 28

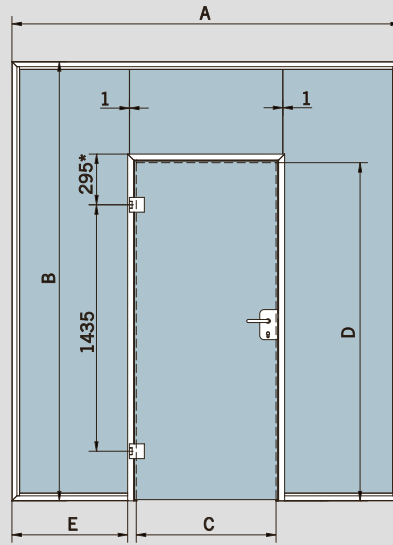

* Angabe für Office Bänder
bei Verwendung von Studio = 254 mm
* Indication for Office hinges
when using Studio = 254 mm

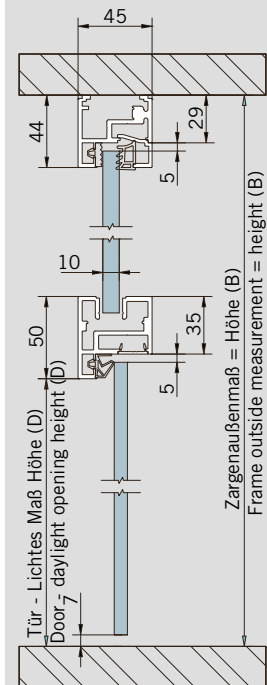
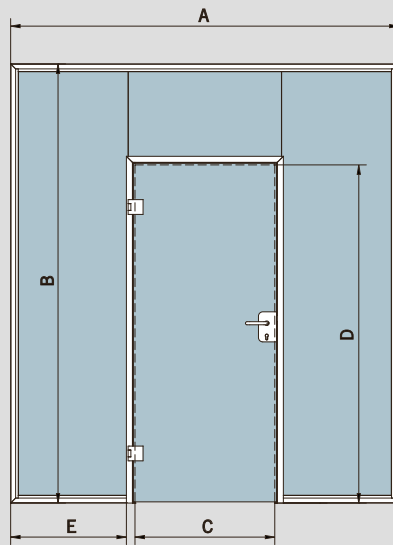

Tür - Lichtes Maß Höhe (D)
Door - daylight opening height (D)

Zargenaußenmaß = Höhe (B)
Frame outside measurement = height (B)

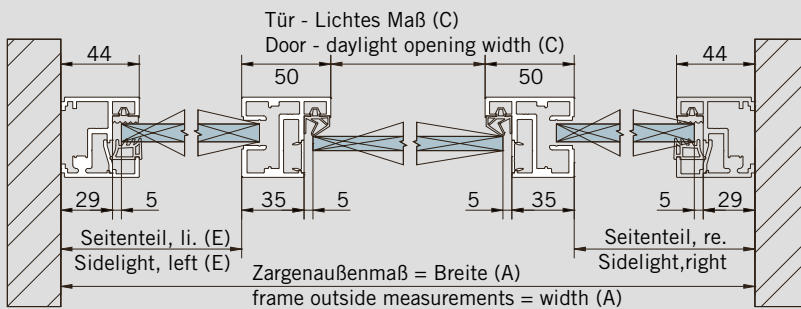

Tür - Lichtes Maß (C)
Door - daylight opening width (C)

Zargenaußenmaß = Breite (A)
frame outside measurements = width (A)

Seitenteil, li. (E)
Sidelight, left (E)

Seitenteil, re.
Sidelight, right

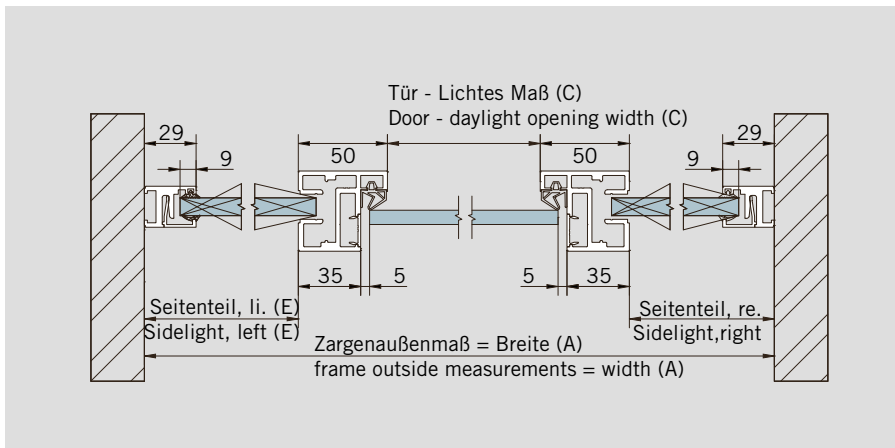
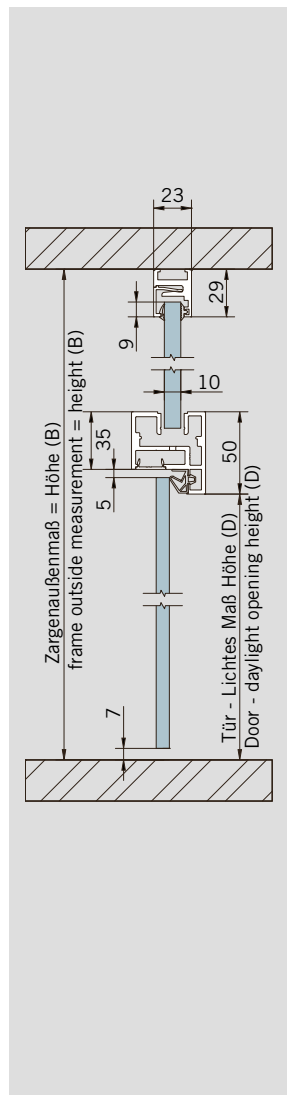
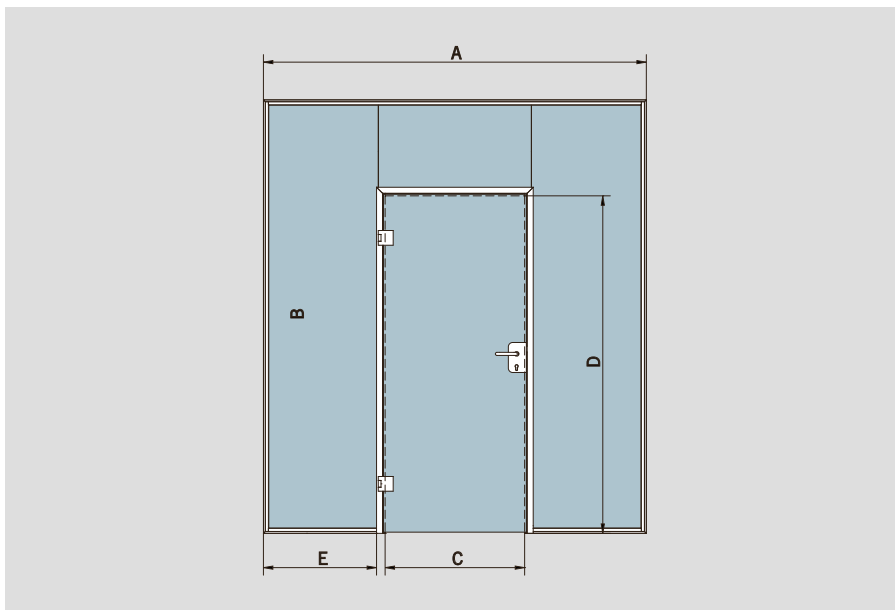
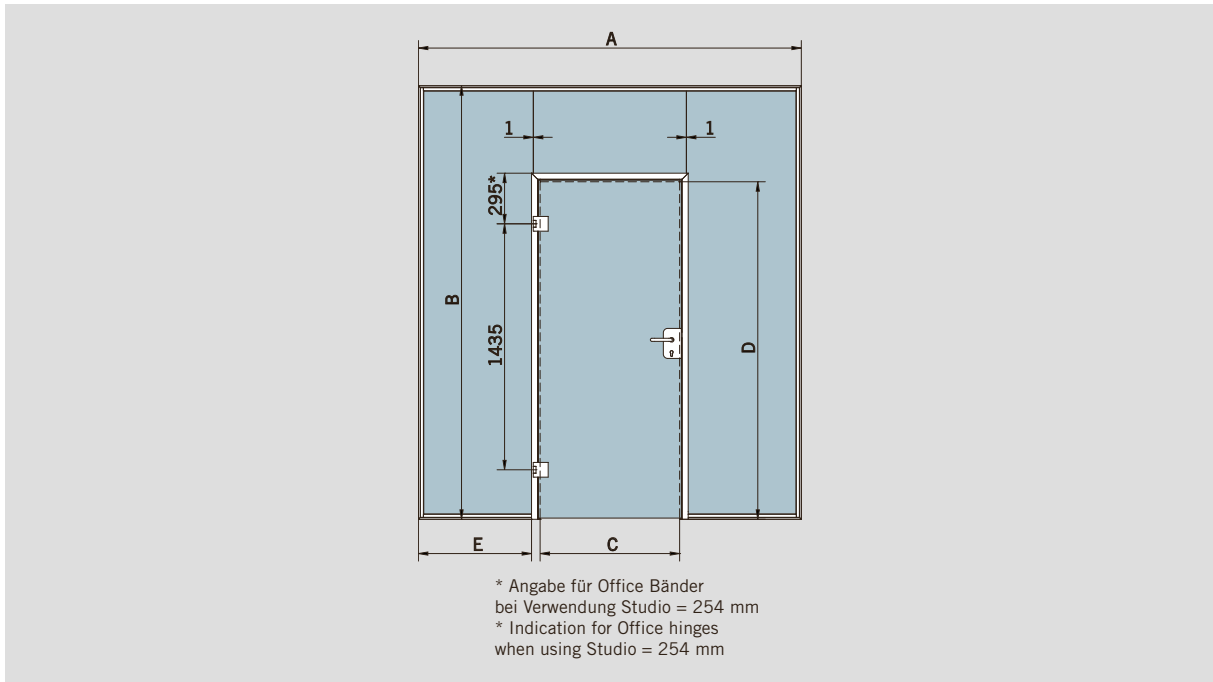

Wandanschluss-Rahmensystem MR 28

bestehend aus einem Rahmenprofil (rastergebohrt), einem Spannprofil und zwei Anschlaggummiprofilen (PVC, transparent). Die zierliche und elegante Rahmenlösung eignet sich sowohl für den Innen- als auch für den Außenbereich und zeichnet sich durch eine sehr einfache Montage aus. Die Ansichtsbreite beträgt lediglich 28 mm. In Kombination mit AT 50 wird immer eine Glasstärke von 10 mm eingesetzt. Über die Profile erfolgt keine Lastabtragung. Die Demontage und der Wiedereinbau sind problemlos möglich.

Anwendung:

z. B. umlaufender Rahmen für Ganzglas-Anlagen mit Befestigung zur Wand und zur Decke.

Wall connecting frame system MR 28

comprising a frame profile (series-drilled), a clamping profile and two contact rubber extrusions (PVC, transparent).

These decorative and elegant frame solutions are suitable for both indoor and outdoor applications and are characterised by their remarkably easy installation.

The viewface width is just 28 mm. In combination with AT 50 only suitable for glass thickness of 10 mm. No load transfer by the profiles. Can be readily removed and re-installed else-where.

Applications:

e.g. surrounding frame for toughened glass systems for fixing to walls and ceilings

Grundprofil

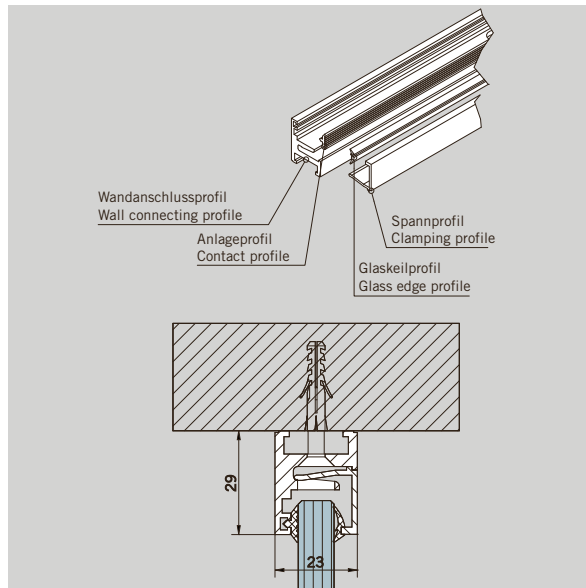

Base profile

MR 28
in 6000 mm Lagerlängen,
ohne PVC-Profilie
Art.-Nr. 07.241

Gewicht in kg/m:
LM 0,802

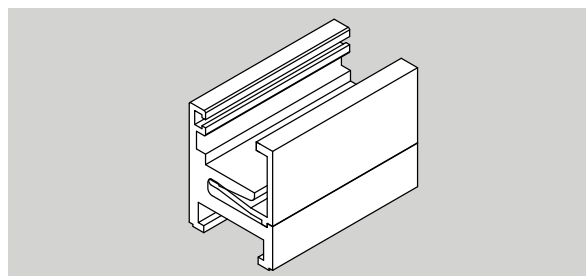

MR 28
in 6000 mm stock length,
without PVC profile
Art. No. 07.241

Weight in kg/m:
aluminium 0,802

MR 28
in Fixlängen
Art.-Nr. 07.251

Gewicht in kg/m:
LM 0,802

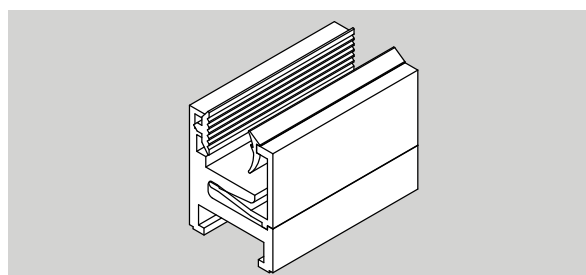

MR 28
in fixed length
Art. No. 07.251

Weight in kg/m:
aluminium 0,802

Stirnabdeckung MR 22
Art.-Nr. 07.245

Gewicht in kg/Stck:
LM 0,002

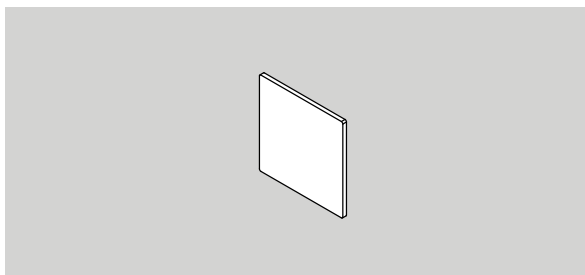
End mounted plate MR 22
Art. No. 07.245

Weight in kg/pc:
aluminium 0,002

Stirnabdeckung MR 28
Art.-Nr. 07.246

Gewicht in kg/Stck:
LM 0,002

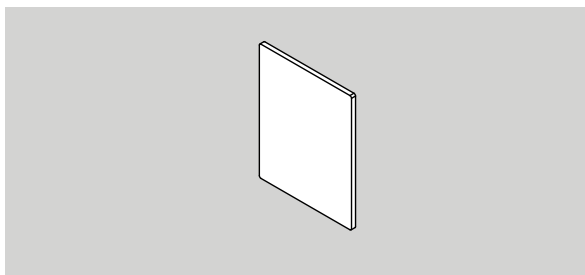
End mounted plate MR 28
Art. No. 07.246

Weight in kg/pc:
aluminium 0,002

Anlageprofil
 in 50 m Lagerlängen (Rolle)
Art.-Nr. 07.255

Gewicht in kg/m:
PVC 0,023

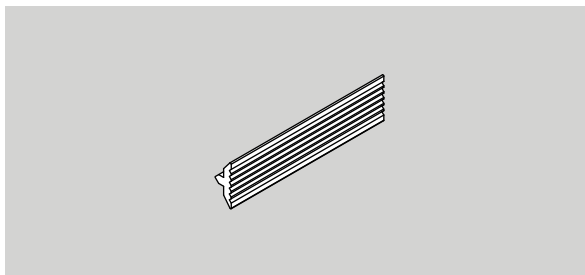
Contact profile
 in 50 m stock length (roll)
Art. No. 07.255

Weight in kg/m:
PVC 0,023

Glaskeilprofil
 2 mm,
 für 10 mm Glasdicke,
 in 50 m Lagerlängen (Rolle)
Art.-Nr. 07.253

Gewicht in kg/m:
PVC 0,016

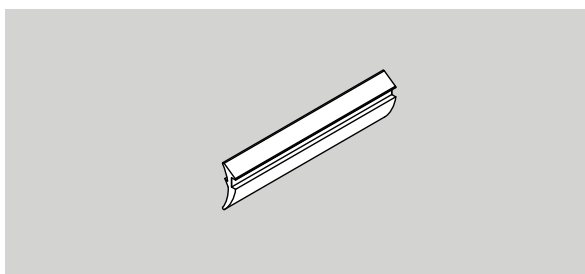

Glass edge profile
 2 mm,
 für 10 mm glass thickness,
 in 50 m stock length (roll)
Art. No. 07.253

Weight in kg/m:
PVC 0,016

Eckverbinder MR 28
Art.-Nr. 07.247

Gewicht in kg/Stck:
LM 0,0021

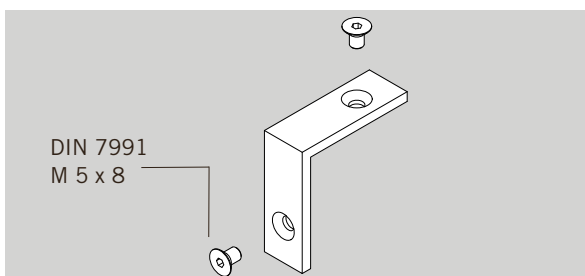
2 Schrauben DIN 7991
 M 5 x 8 im Lieferumfang
 enthalten

Corner connection MR 28
Art. No. 07.247

Weight in kg/pc:
aluminium 0,0021

2 screws DIN 7991
 M 5 x 8 are included in
 delivery

**ALEXA PT 35 –
Pendeltürzarge für
10 mm Glas**

Mit verdeckter Befestigung für ein- und doppel­flügelige Türanlagen, mit Oberlicht und/oder festen Seitenteilen.

Passend für DORMA Universal-Eckbeschläge, ARCOS Universal-Eckbeschläge und entsprechende Schlösser und Griffe.

Feststehende Teile werden mit Silicon versiegelt.

Max. Türgewicht 80 kg

Standard-Oberflächen

- LM silber EV1 (101)
- LM ähnlich Niro matt C 31 (113)

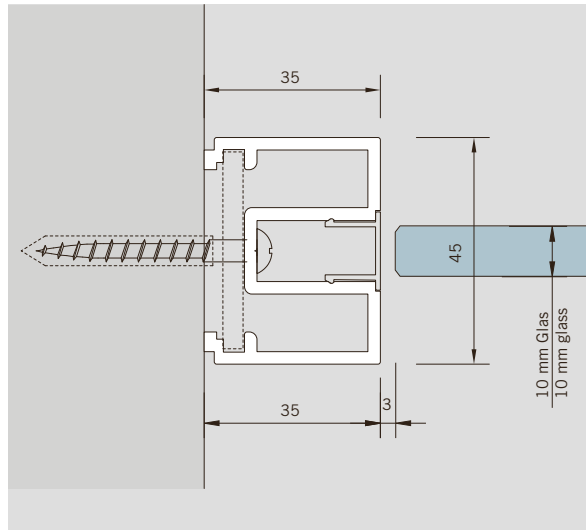
**ALEXA PT 35 –
double action door frame
for 10 mm glass**

With concealed fixing for single and double action door assemblies, with over-panel and/or fixed sidelights.

Suitable for DORMA Universal patch fittings, ARCOS Universal patch fittings and appropriate locks and handles.

Fixed parts will be sealed with silicon.

Max. door weight 80 kg

Standard finishes

- aluminium silver EV1 (101)
- aluminium similar satin stainless steel C 31 (113)

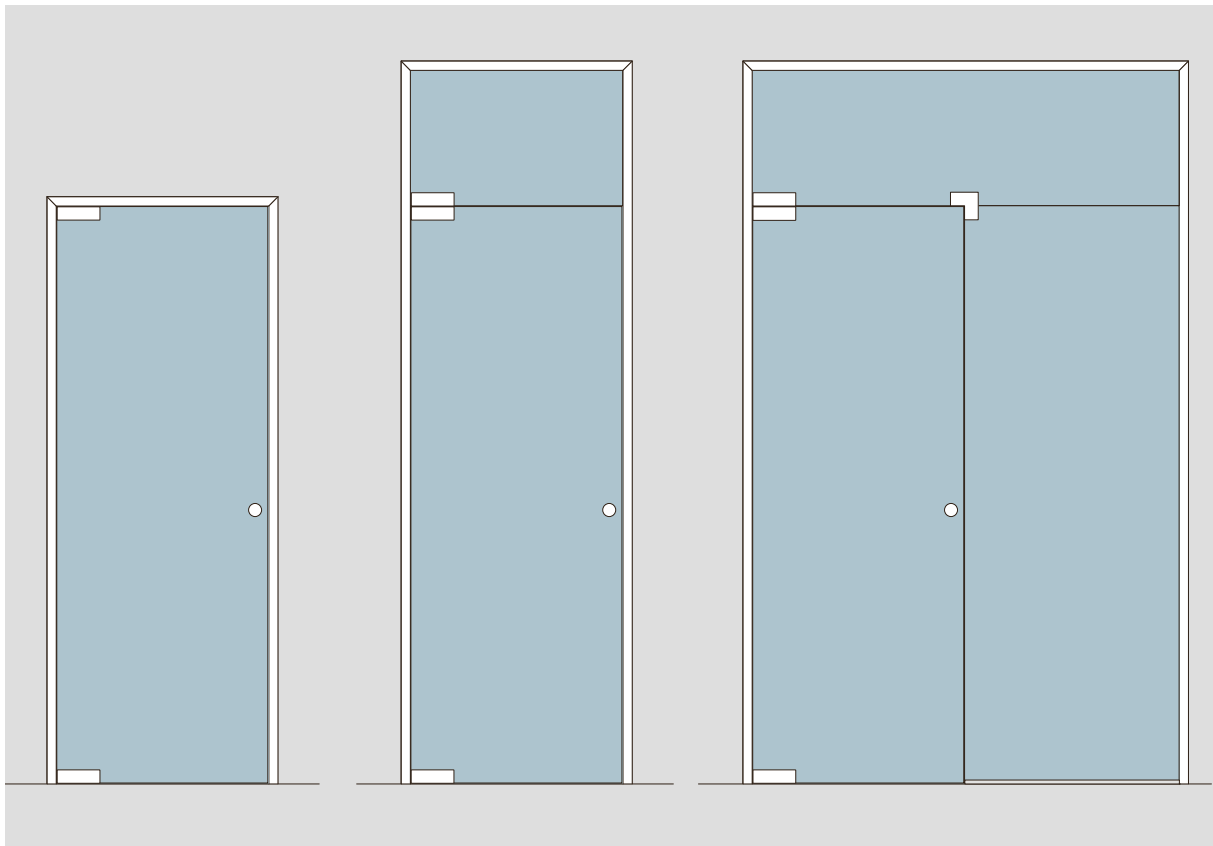

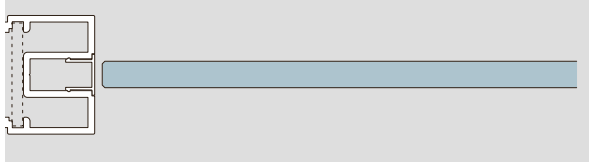
Die Profile / Profiles

ALEXA PT 35 Zargenprofil mit Clipsprofil
 ALEXA PT 35 frame profile with cover clip profile

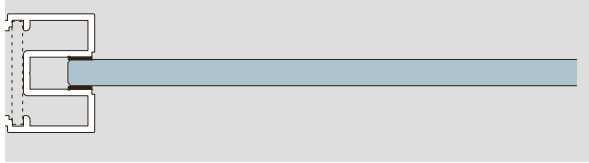

ALEXA PT 35 Zargenprofil mit Glaseinstand
 ALEXA PT 35 frame profile with glass penetration

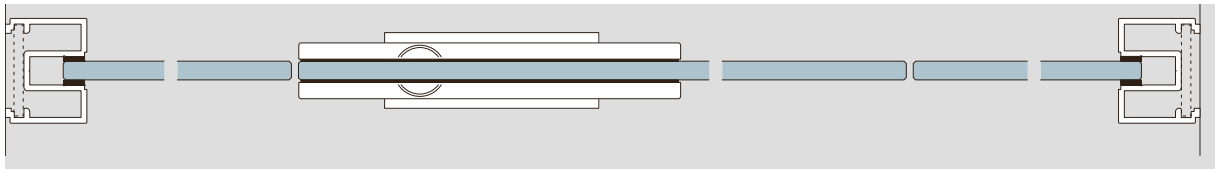
Die Beschlagvarianten-Beispiele / fitting variants – examples

ALEXA PT 35 mit DORMA Universal Eckbeschlägen, Bodendrehlager
 ALEXA PT 35 with DORMA Universal patch fitting, floor pivot bearing

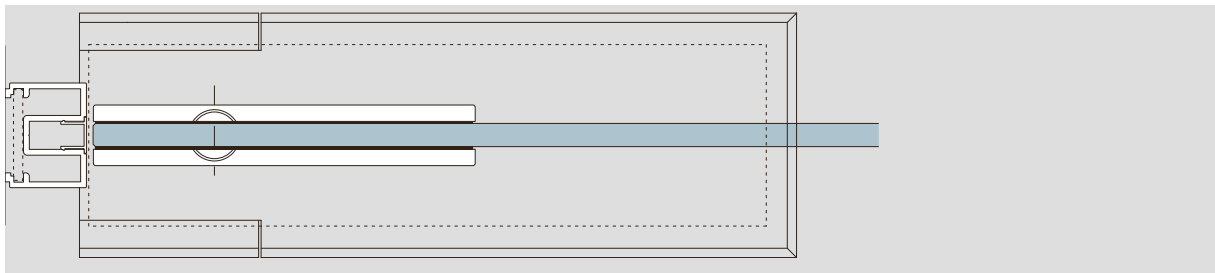

ALEXA PT 35 mit DORMA Universal Eckbeschlägen, Bodentürschließer BTS 75 V
 ALEXA PT 35 with DORMA Universal patch fitting, floor closer BTS 75 V

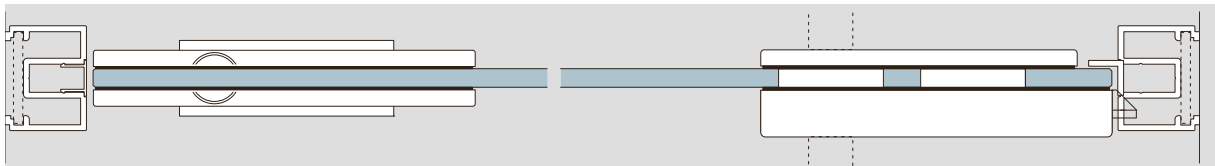

ALEXA PT 35 mit DORMA Universal Eckbeschlägen,
 Bodendrehlager
 ALEXA PT 35 with DORMA Universal patch fitting,
 floor pivot bearing

Schloss, Studio Rondo / Classic
 lock, Studio Rondo / Classic

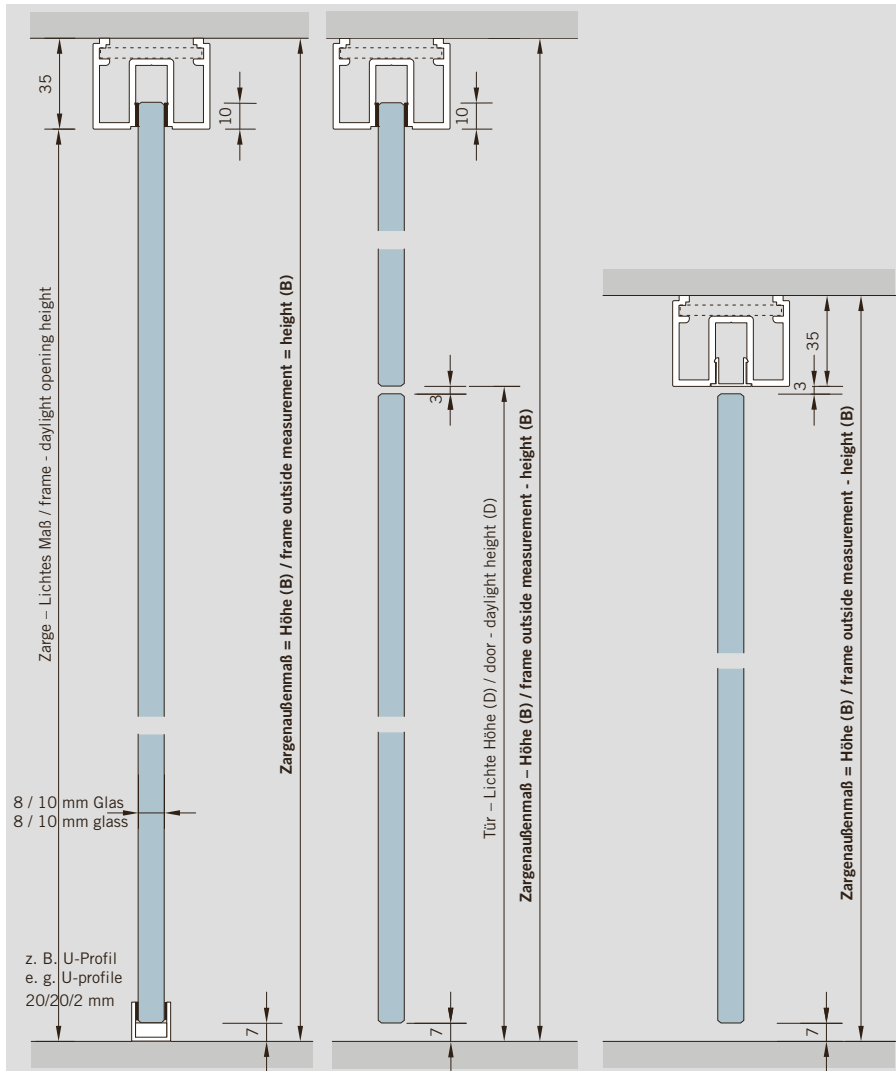

Schnitt / Festverglasung
sectional cut / fixed glazing

Schnitt / Tür mit Oberlicht
sectional cut / door with
overpanel

Schnitt / Tür
sectional cut / door

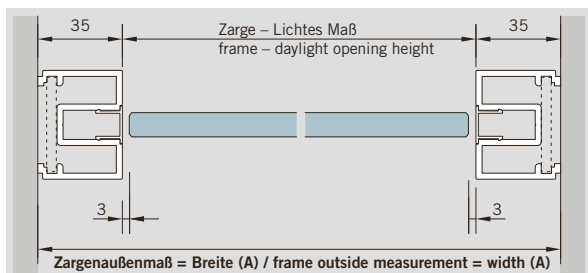

Grundriss / Tür / plan / door

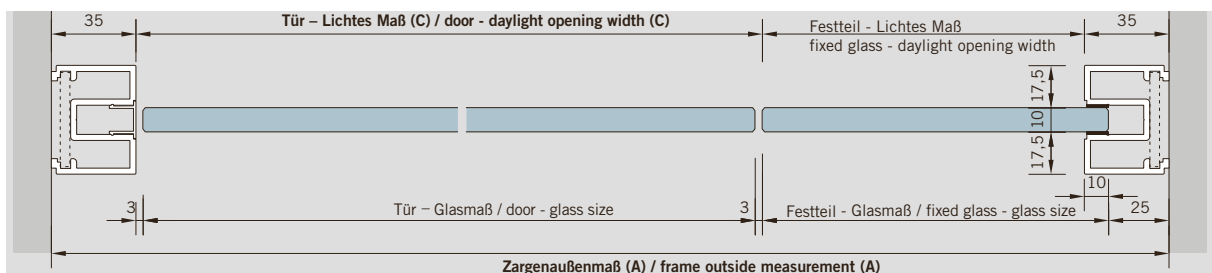

Grundriss / Tür mit Festverglasung / plan / door with fixed glazing

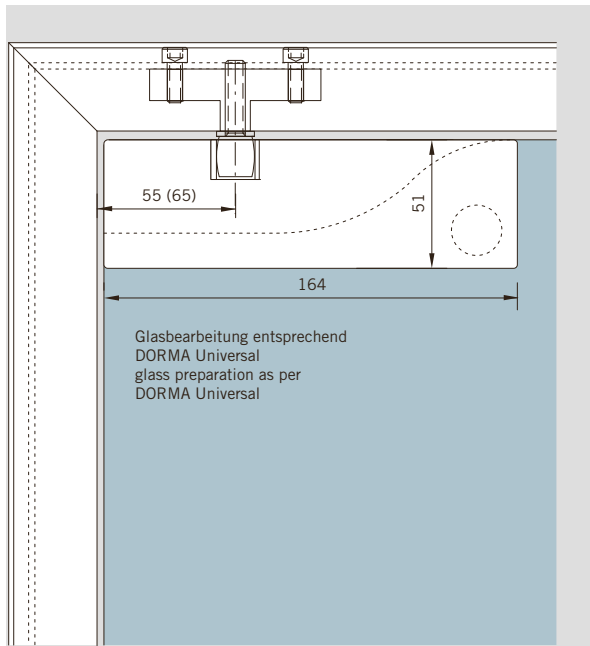

Ansicht DORMA Universal Eckbeschlag oben
view DORMA Universal top patch fitting

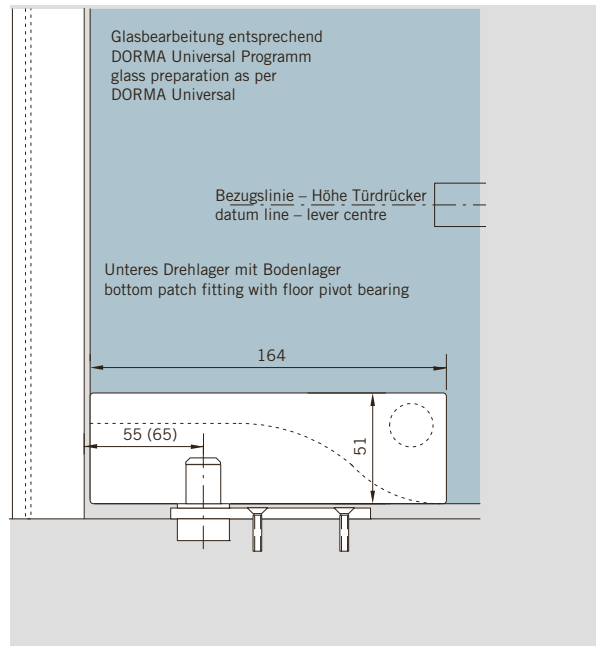

DORMA Universal Eckbeschlag unten, Ansicht
view DORMA Universal bottom patch fitting

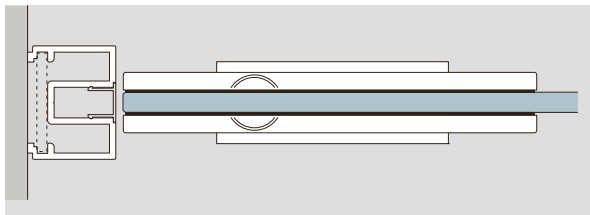

DORMA Universal Eckbeschlag, Grundriss
plan DORMA Universal patch fitting

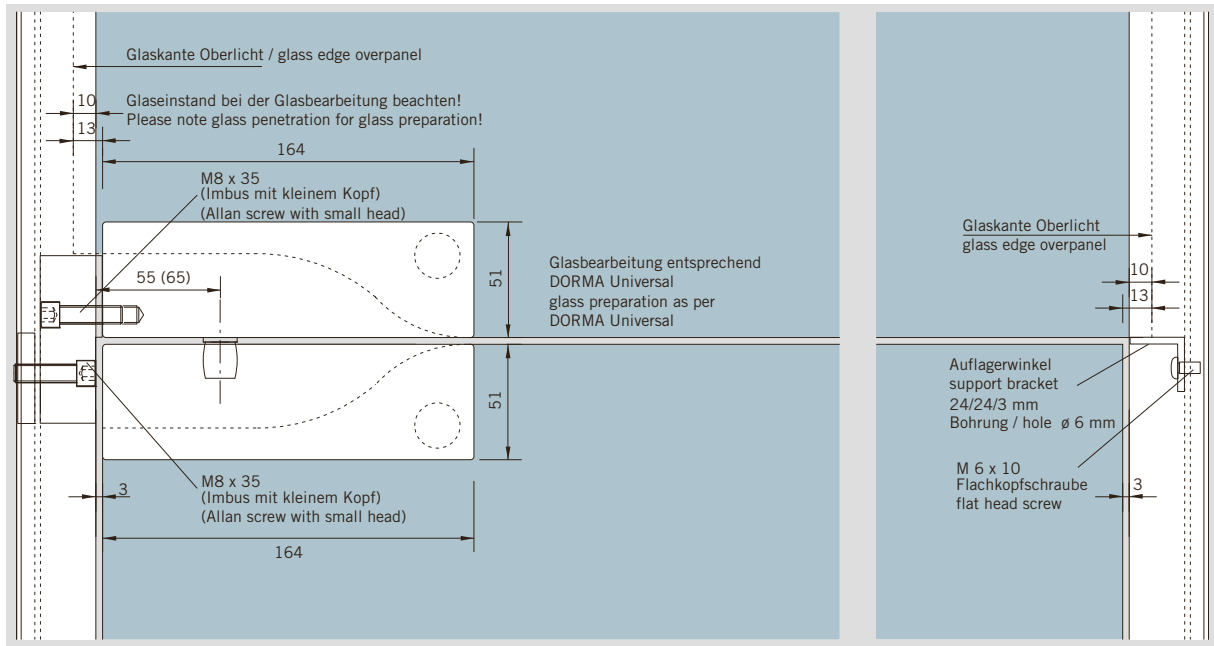

Ansicht DORMA Universal Eckbeschlag
view DORMA Universal patch fitting

Ansicht Auflager – Oberlicht
view overpanel support

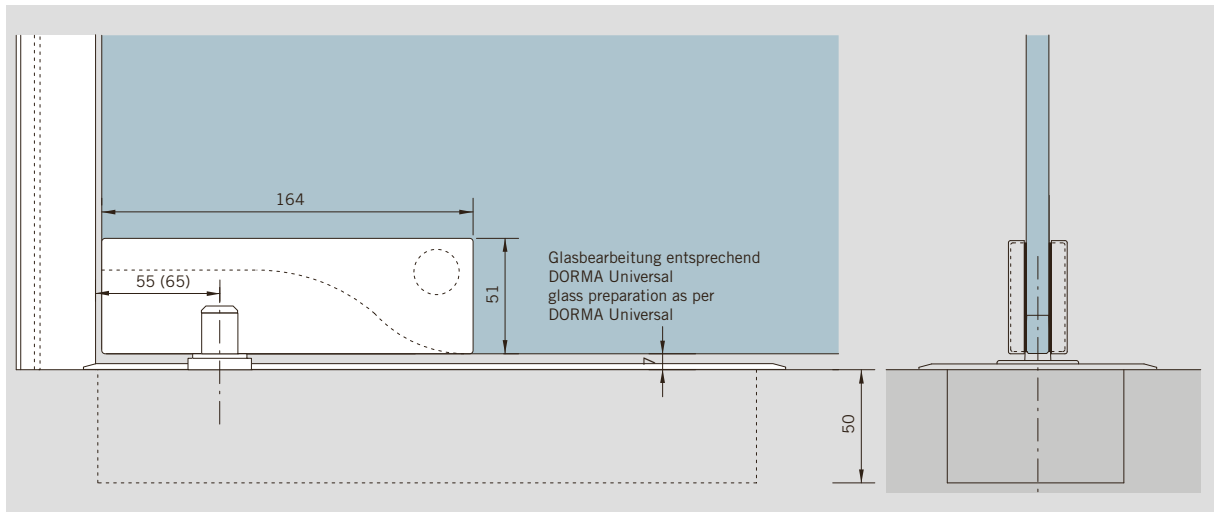

Ansicht DORMA Universal Eckbeschlag, Bodentürschließer
view DORMA Universal patch fitting, floor spring

Schnitt – Bodentürschließer
sectional cut – floor spring

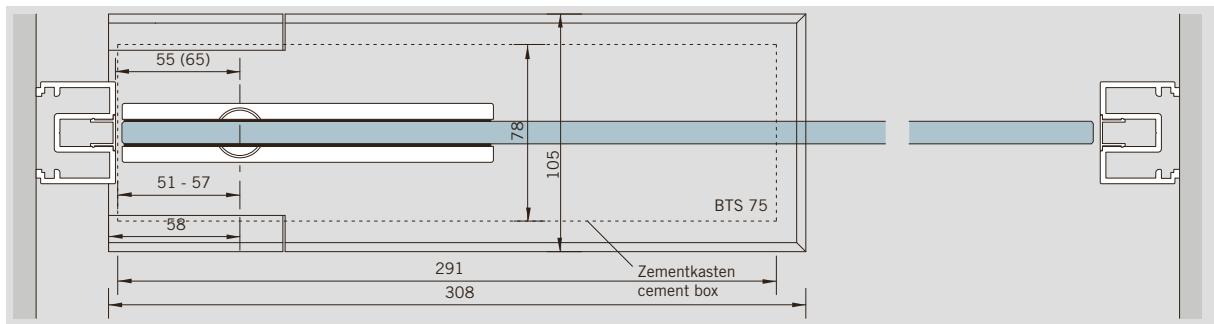

Grundriss, Pendeltür mit DORMA BTS 75 V / plan, double acting door with DORMA BTS 75 V

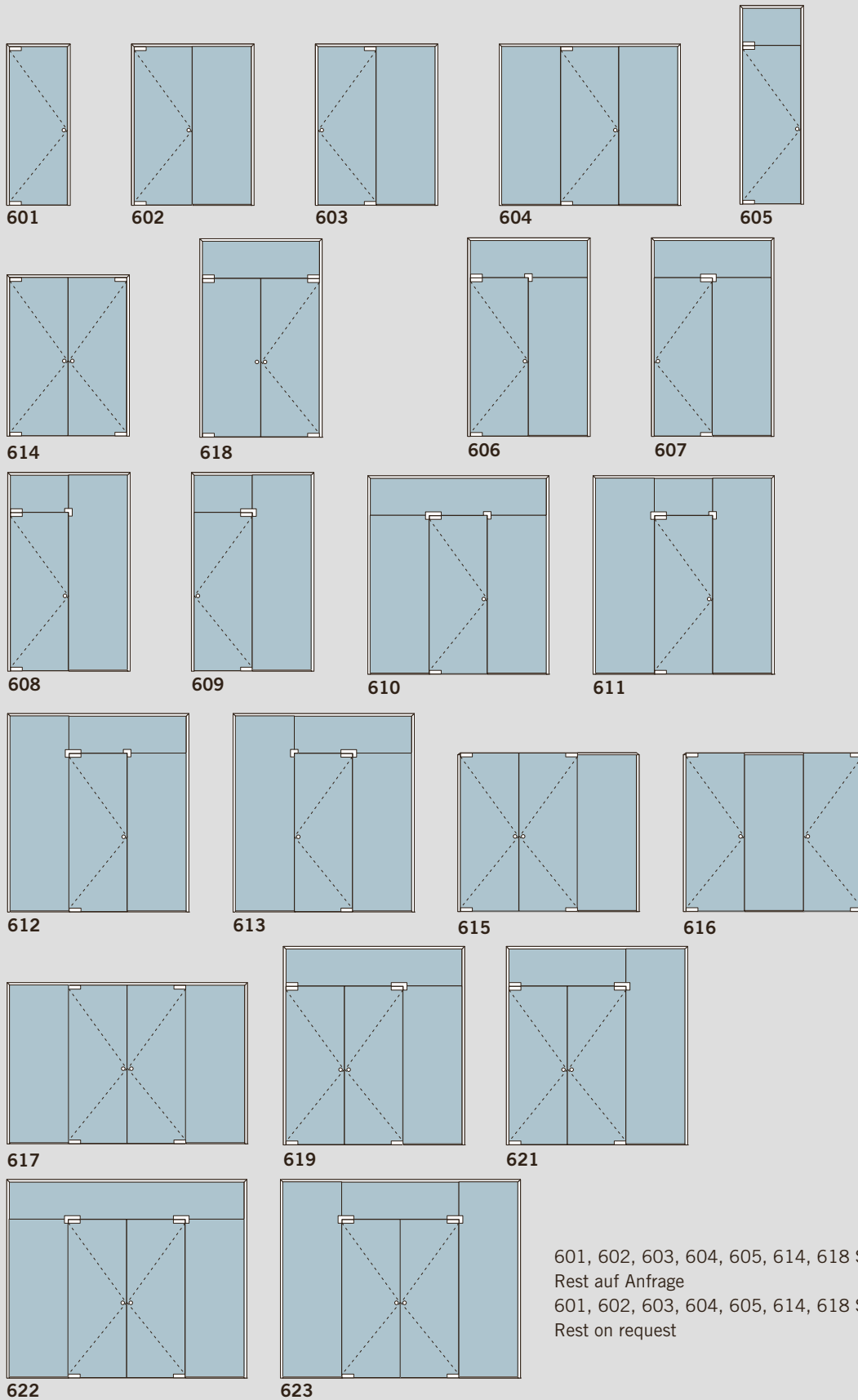



DORMA-Glas GmbH
Postfach 32 68
D-32076 Bad Salzflun
Max-Planck-Straße 33 - 45
D-32107 Bad Salzflun
Tel. +49 5222 924-0
Fax +49 5222 21009
www.dorma-glas.com